

FREEBORN

Cope and Pattern Sets (6 Cutters per Set)

PART#	PRICE	EASED EDGE PRICE
MC-50-010 thru 070	\$348.00	\$417.60
PC-10-010 thru 070	\$408.75	\$490.50
MT-50-010 thru 070	\$381.75	\$458.10
PT-10-010 thru 070	\$450.00	\$540.00

Versatile and easy-to-use. These 6 cutter sets are designed to perform the 3 functions shown. Our standard sets cut 1/4" wide by 3/8" deep tongue and groove. Our common minor diameter requires NO fence adjustment when changing from cope to pattern cuts (3/8" tongue only). Counterclockwise rotation with wood fed face down. Optional tongue and groove cutters, and eased edge are available.

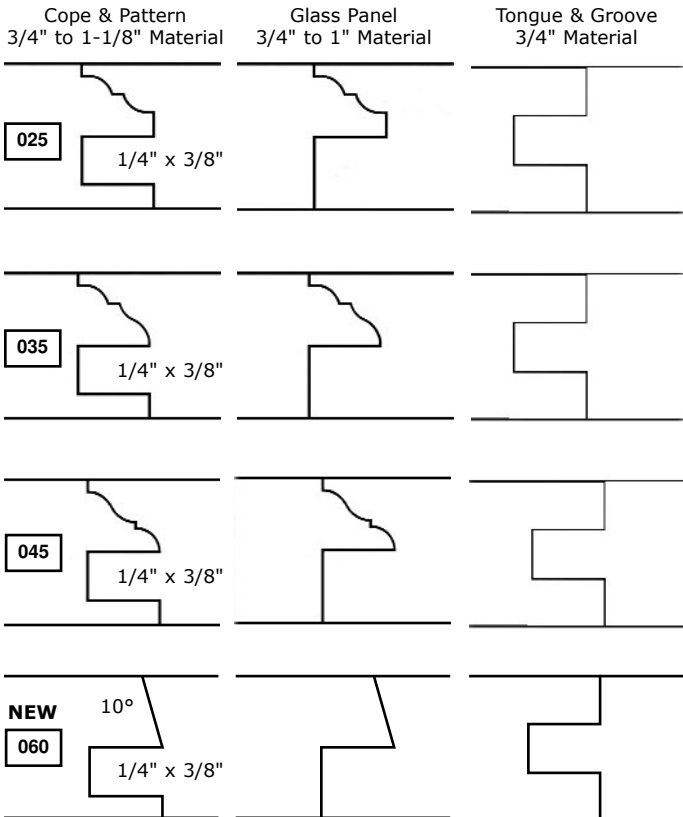
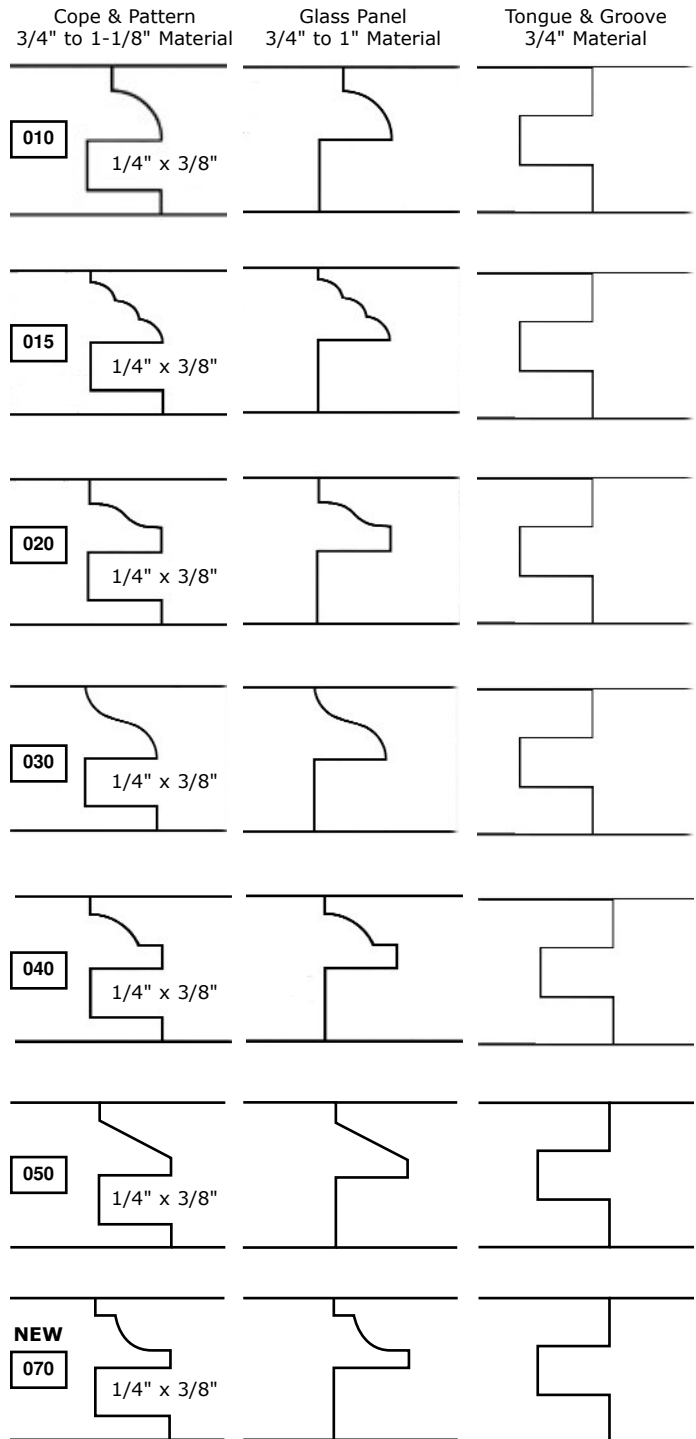
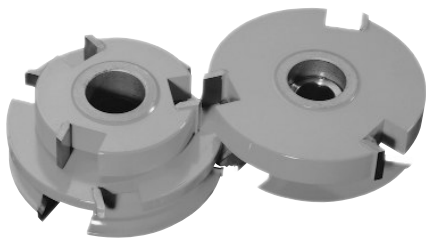

(M) Mini-Pro - 3/4" bore (P) Pro-Line - 1-1/4" bore (C) Carbide Tip - Orange (T) Tantung® Tip - Yellow

Mini-Pro Cutters: 3 wing, 2-15/16" diameter, 3/4" bore, runs with a 2-3/16" diameter rub bearing (AM-90-035 \$40.50)
Pro-Line Cutters: 3 wing, 4" diameter, 1-1/4" bore, runs with a 3-1/4" diameter (AP-90-052 \$45.75)

FREEBORN WOOD SAMPLES ARE SHOWN ACTUAL SIZE

FREEBORN

Cope and Pattern Sets (6 Cutters per Set) cont.

PART#	PRICE	EASED EDGE PRICE
MC-50-145	\$365.25	\$438.30
PC-10-145	\$429.75	\$515.70
MT-50-145	\$429.00	\$514.80
PT-10-145	\$507.00	\$608.40

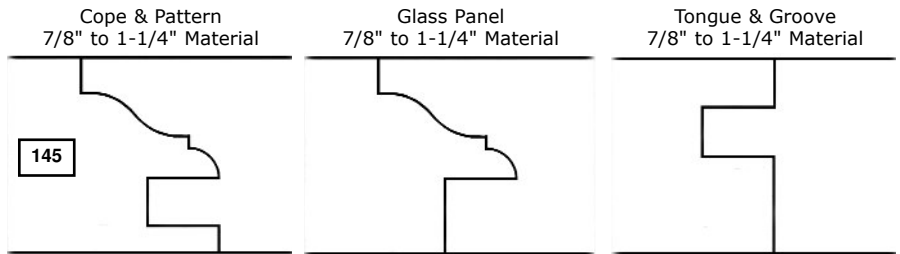

Cope and Pattern Stacking Instructions

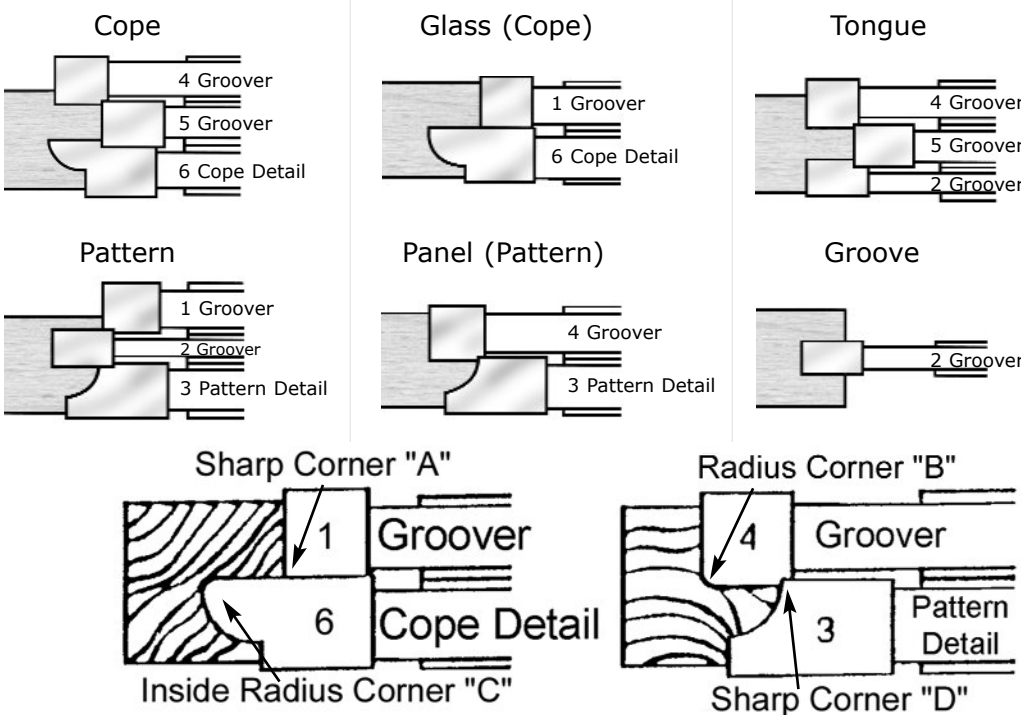

Each function of the 6 piece cope and pattern set requires a different cutter configuration.

For desired results, use the following guide to set up each operation.
REMEMBER: Always stagger cutters when stacking.

If you use an Eased Edge set to do glass panels, you'll have this problem if you do not have an extra cutter as on next page.

Double Sided Cope and Pattern (6 Cutters per Set)

PART#	PRICE	EASED EDGE PRICE
MC-50-310, 320 or 340	\$404.25	\$485.10
PC-10-310, 320 or 340	\$467.25	\$560.70
MT-50-310, 320 or 340	\$467.25	\$560.70
PT-10-310, 320 or 340	\$548.25	\$657.90
PT-10-230	\$489.00	\$586.80

Standard sets cut 1/4" wide by 3/8" deep tongue and groove. They are built to cut 1" to 1-1/4" cabinet doors, depending on set. Optional tongue and groove cutters, and eased edge are also available.

1" to 1-1/8" Material

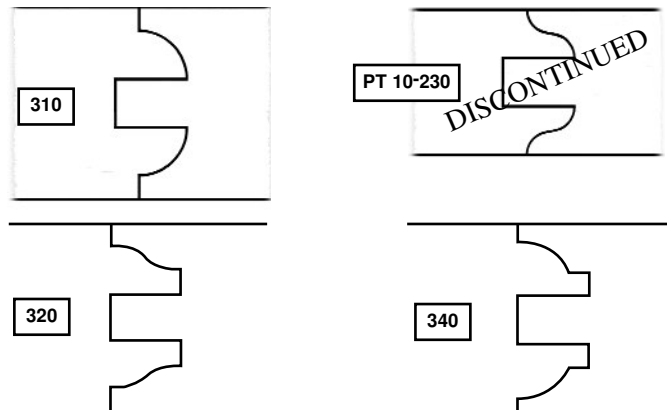

Flat Cope and Pattern (6 Cutters per Set)

PART#	PRICE	EASED EDGE PRICE
MC-50-500 or 550	\$285.75	\$342.90
PC-10-500 or 550	\$314.25	\$377.10
MT-50-500 or 550	\$336.00	\$403.20
PT-10-500 or 550	\$369.75	\$443.70

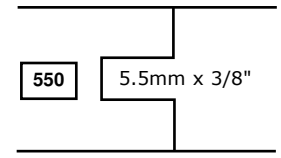
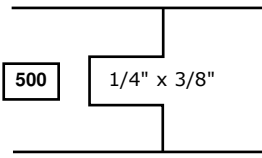

Tongue & groove sets for flat panel doors will also cut glass panels without additional cutters. Our common minor diameter requires NO fence adjustment when changing from cope to pattern cuts (3/8" tongue only). 3/4" to 1-1/8" material. Customer can choose from 9 different tongue sizes!

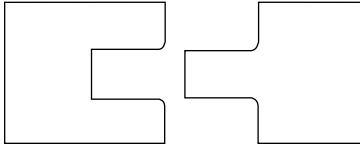
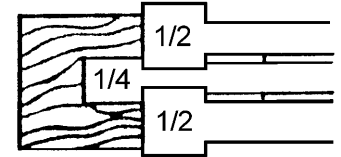
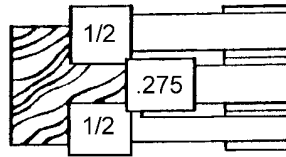

Eased Edge Profile

Optional Eased Edge Sets

PART#	DESCRIPTION	PRICE
FC17920	Extra Cutter to do Glass 1-1/4" Bore	\$199.00
FC17920B	Extra Cutter to do Glass 3/4" Bore	\$199.00

Optional eased edges are now stock items. **Call for pricing.** Eased edges are available on all 10 and 50 series cope and patterns. Can not do glass panel or tongue and groove without custom groovers.

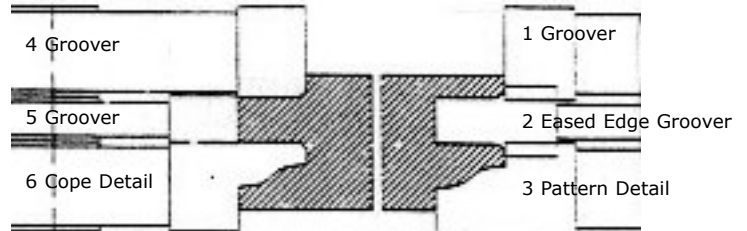
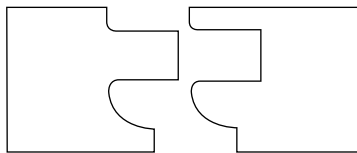

P-10-020 With Eased Edges.

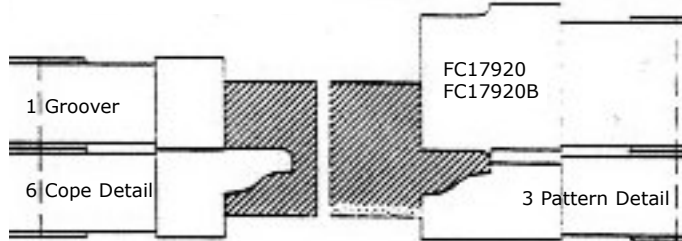
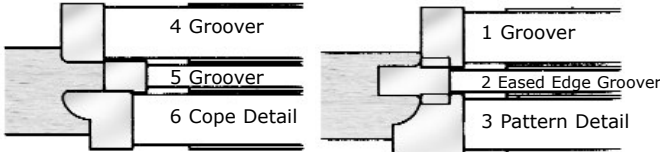

2 Piece Center Groover Sets

PART#	PRICE
MC-50-501 thru 503 or 601 thru 608	\$141.00
PC-10-501 thru 503 or 601 thru 608	\$150.75
MT-50-501 thru 503 or 601 thru 608	\$150.75
PT-10-501 thru 503 or 601 thru 608	\$177.75

At time of purchase, you may substitute the following center groover sets in your cope & pattern set at no additional charge except for the 700 series which costs \$20.00 extra. Available on all M-50 and P-10 series cope and patterns. M-50-010 profile used to show tongue and groove options.

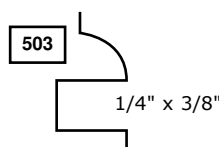
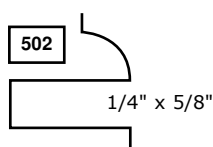
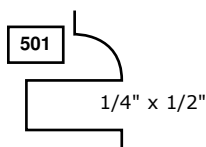
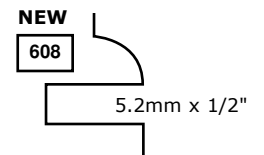
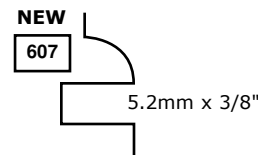
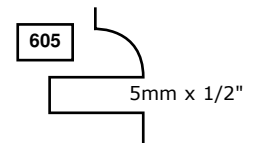
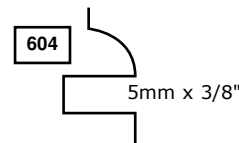
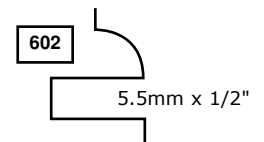
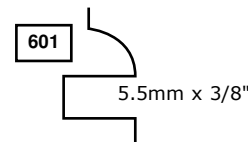

(M) Mini-Pro - 3/4" bore

(P) Pro-Line - 1-1/4" bore

(C) Carbide Tip - Orange

(T) Tantung® Tip - Yellow

FREEBORN WOOD SAMPLES ARE SHOWN ACTUAL SIZE

FREEBORN

Optional Eased Edge Center Cutter Sets for Rubber Extrusions

PART#	PRICE	EASED EDGE PRICE
MC-50-700	\$157.50	\$189.00
PC-10-700	\$168.00	\$201.60
MT-50-700	\$168.00	\$201.60
PT-10-700	\$195.00	\$234.00

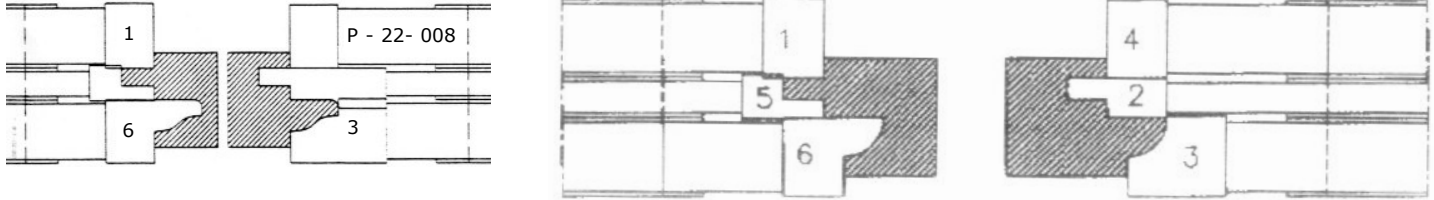
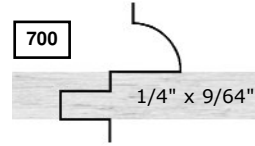

Rub Spacers for Cope and Pattern (Not a Ball Bearing Spacer)

PART#	BORE	TONGUE	PRICE	PART#	BORE	TONGUE	PRICE
AM-50-807	3/4	1/4 x 1/2	\$39.00 Each	AM-50-602	3/4	5.5mm x 1/2	\$39.00 Each
AP-10-807	1-1/4	1/4 x 1/2	\$39.00 Each	AP-10-602	1-1/4	5.5mm x 1/2	\$39.00 Each
AM-50-803	3/4	1/4 x 3/8	\$39.00 Each	AM-50-604	3/4	5.5mm x 3/8	\$39.00 Each
AP-10-803	1-1/4	1/4 x 3/8	\$39.00 Each	AP-10-604	1-1/4	5.5mm x 3/8	\$39.00 Each
AM-50-502	3/4	1/4 x 5/8	\$39.00 Each	AM-50-605	3/4	5mm x 1/2	\$39.00 Each
AP-10-502	1-1/4	1/4 x 5/8	\$39.00 Each	AP-10-605	1-1/4	5mm x 1/2	\$39.00 Each
AM-50-806	3/4	5.5mm x 3/8	\$39.00 Each				
AP-10-806	1-1/4	5.5mm x 3/8	\$39.00 Each				



Optional rub spacer available for M-50 and P-10 series cope and pattern sets. Replaces center cutter on cope side.

Double Sided Cope and Pattern (8 Cutters per Set)

PART#	PRICE
MC-51-010 thru 030	\$631.50
PC-11-010 thru 030	\$743.25
MT-51-010 thru 030	\$699.75
PT-11-010 thru 030	\$817.50

Standard sets cut 1/4" x 5/8" or 1/2" x 5/8" deep tongue and groove. Mini-pro not to be used on 1/2" spindle. These 8 piece cutter sets are built to cut both 3/8" passage doors and 1-3/4" entry doors simply by changing the center cutters. A 2-piece glass panel groover set is also available to run with these sets.

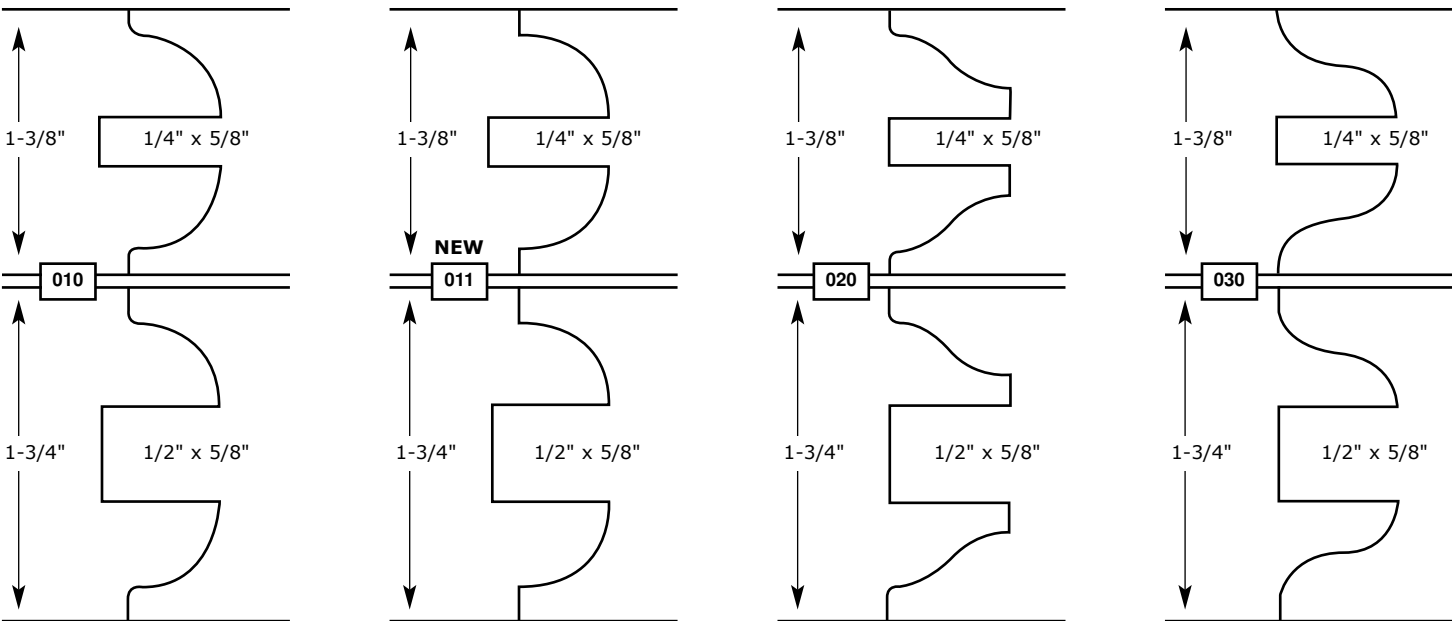

Mini-Pro Cutters: 3 wing, 2-15/16" diameter, 3/4" bore, runs with a 1-11/16" diameter rub bearing (AM-90-027 \$40.50)
Pro-Line Cutters: 3 wing, 4" diameter, 1-1/4" bore, runs with a 2-3/4" diameter (AP-90-044 \$45.75)

Double Sided Cope and Pattern (8 Cutters per Set) cont.

PART#	PRICE	PART#	PRICE
MC-51-040 thru 070	\$631.50	MC-51-500	\$499.50
PC-11-040 thru 070	\$743.25	PC-11-500	\$588.00
MT-51-040 thru 070	\$699.75	MT-51-500	\$549.00
PT-11-040 thru 070	\$817.50	PT-11-500	\$646.50

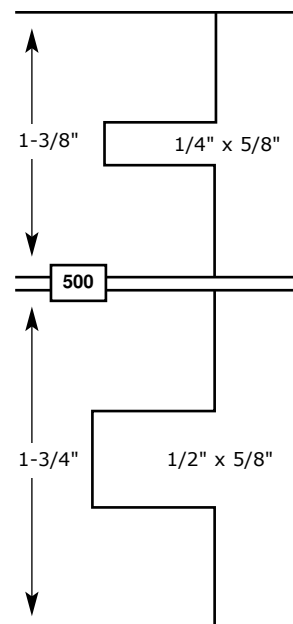
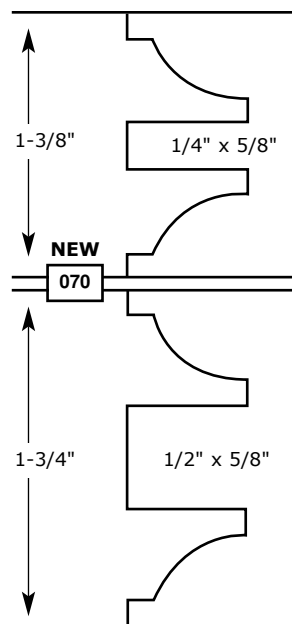
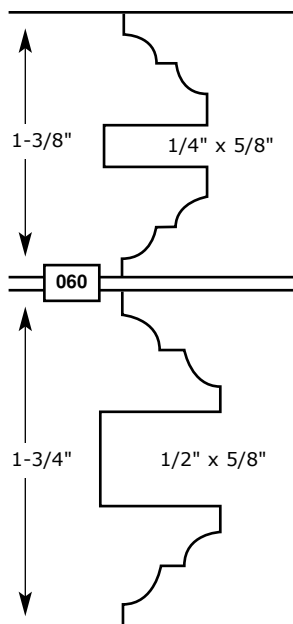
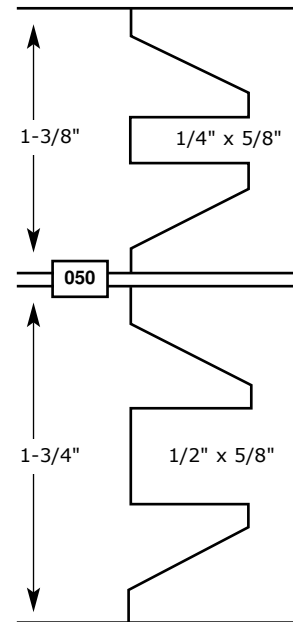
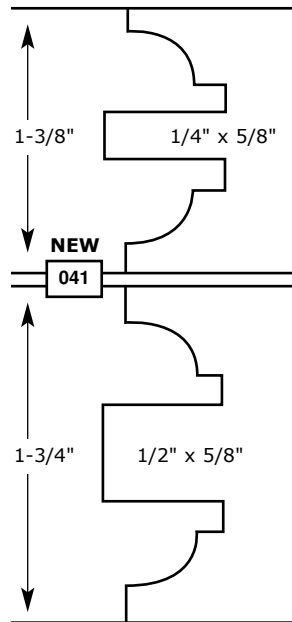
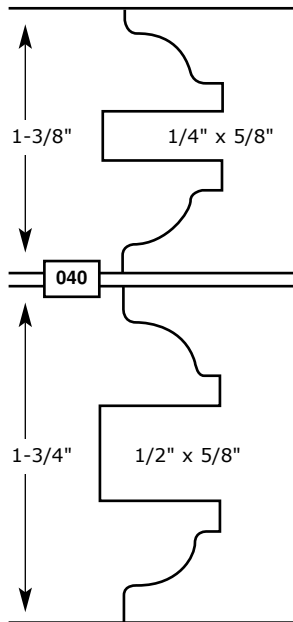

(M) Mini-Pro - 3/4" bore (P) Pro-Line - 1-1/4" bore (C) Carbide Tip - Orange (T) Tantung® Tip - Yellow

Mini-Pro Cutters: 3 wing, 2-15/16" diameter, 3/4" bore, runs with a 1-11/16" diameter rub bearing (AM-90-027 \$40.50)
 Pro-Line Cutters: 3 wing, 4" diameter, 1-1/4" bore, runs with a 2-3/4" diameter (AP-90-044 \$45.75)

FREEBORN WOOD SAMPLES ARE SHOWN ACTUAL SIZE

FREEBORN

Raised Panel Shaper Cutters for 5/8" Material

PART#	PRICE
MC-55-001 thru 013	\$189.00
PC-15-001 thru 013	\$207.75
MT-55-001 thru 013	\$209.35
PT-15-001 thru 013	\$231.75



Wood Samples Shown
Actual Size.

Cutters can also cut 3/4" material when using a back cutter. **For opposite rotation, add 20% to the list price.**

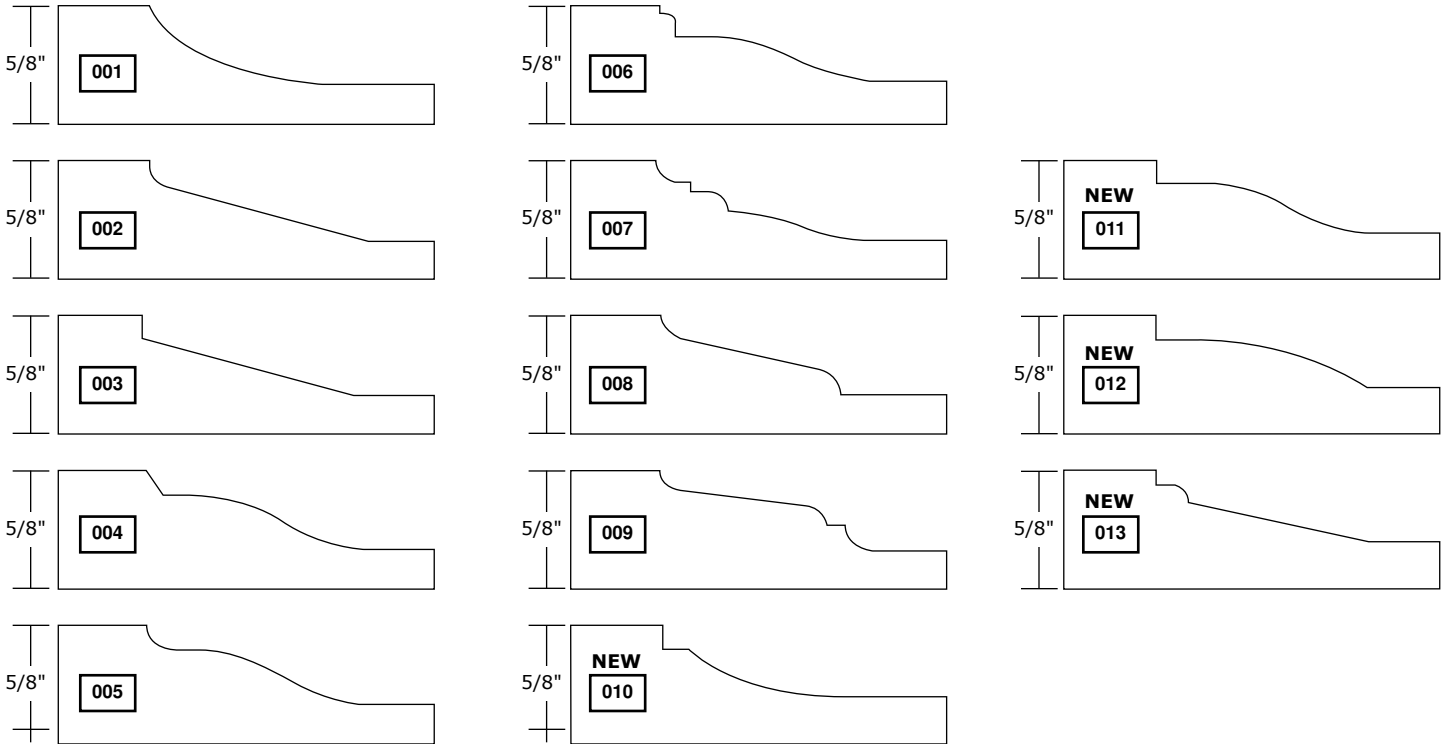

Mini-Pro Cutters: 3 wing, 4-1/2" diameter, 3/4" bore, runs with a 1-5/8" diameter rub bearing (AM-90-026 \$40.50)
Pro-Line Cutters: 3 wing, 6" diameter, 1-1/4" bore, runs with a 3" diameter rub bearing (AP-90-048 \$45.75)

Back Cutters - Raised Panel for 3/4" Material

PART#	PRICE
MC-56-001 or 002	\$141.75
PC-16-001 or 002	\$153.00
MT-56-001 or 002	\$153.00
PT-16-001 or 002	\$168.00

Runs with any M-55 or P-15 series raised panel cutter to cut 3/4" panels.
 Our raised panel cutters are manufactured with 15° SHEAR to produce optimum cuts both with and across the grain.
Does not include raised panel cutter.

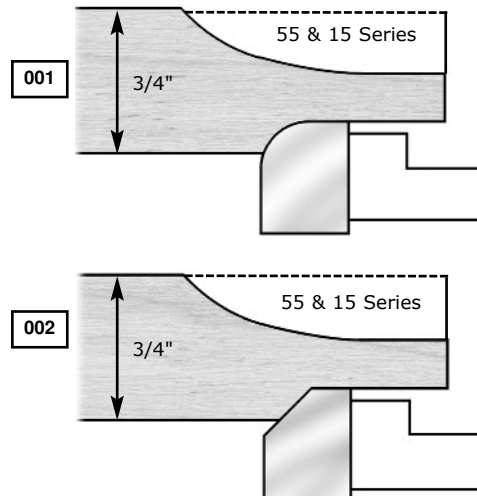

Mini-Pro Cutters: 3 wing, 3-3/8" diameter, 3/4" bore
Pro-Line Cutters: 3 wing, 4-3/4" diameter, 1-1/4"

Raised Panel Shaper Cutters for 3/4" Material

PART#	PRICE
MC-54-001 thru 013	\$189.00
PC-14-001 thru 013	\$207.75
MT-54-001 thru 013	\$209.25
PT-14-001 thru 013	\$231.75



Counterclockwise rotation with wood fed face UP.

Our raised panel cutters are manufactured with 15° SHEAR to produce optimum both with and across the grain.

Mini-Pro Cutters: 3 wing, 4-1/2" diameter, 3/4" bore, runs with a 1-5/8" diameter rub bearing (AM-90-026 \$40.50)
Pro-Line Cutters: 3 wing, 6" diameter, 1-1/4" bore, runs with a 3" diameter rub bearing (AP-90-048 \$45.75)

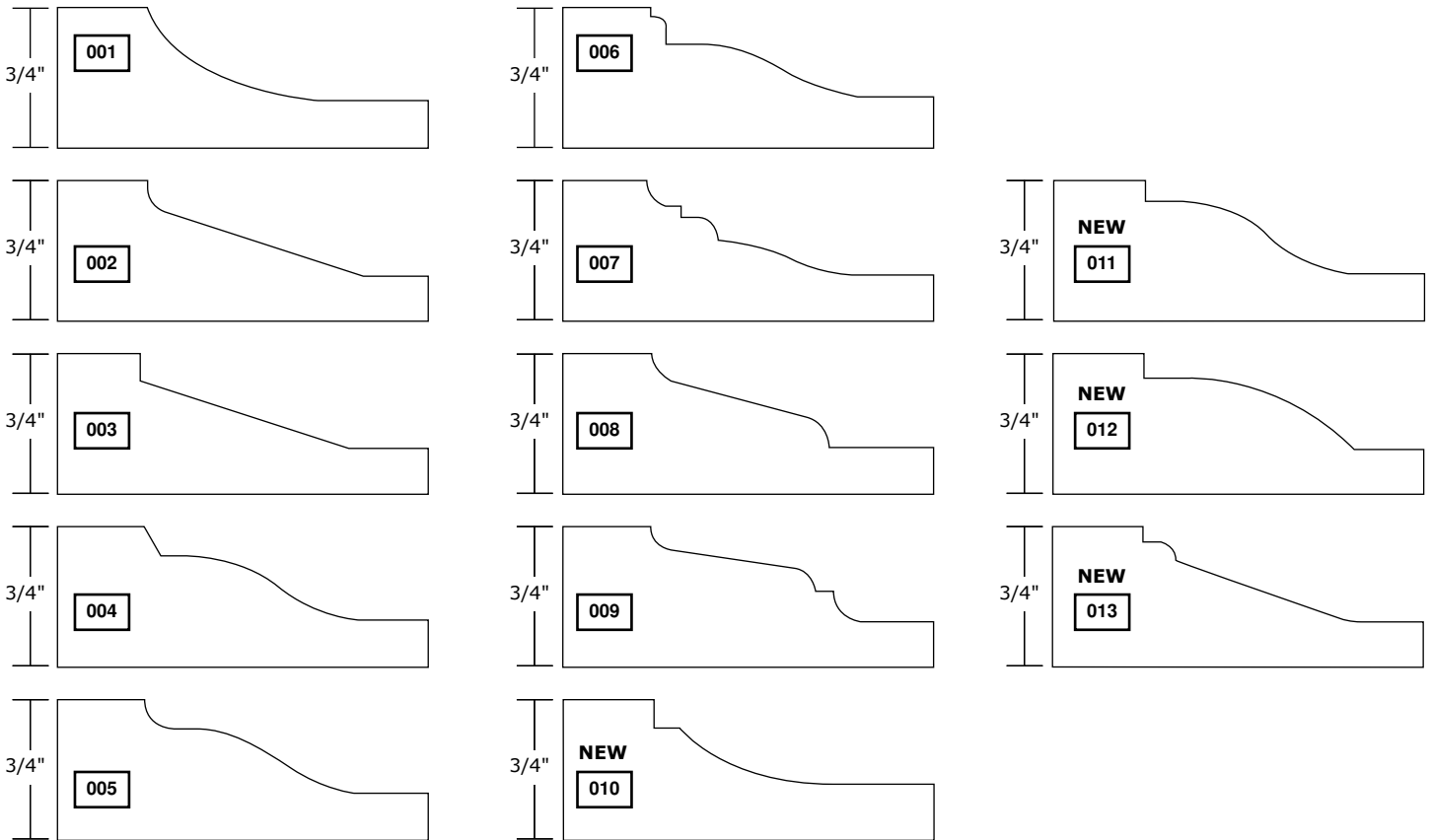

Raised Panel Tongue Trimmer

PART#	PRICE
MC-56-100	\$85.50
PC-16-100	\$92.25
MT-56-100	\$92.25
PT-16-100	\$101.25

Runs with any of our stock raised panel cutters to trim the end of tongue for cabinet doors.

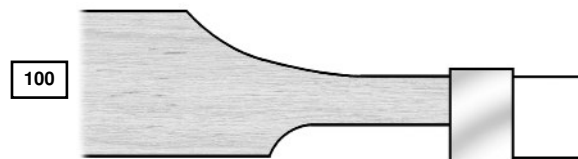

Raised Panel Shaper Cutters 1/2" Material or 3/4" Material Double-Sided Relieved

PART#	PRICE
PC-15-101	\$209.25
PC-15-102	\$209.25
PT-15-101	\$231.75
PT-15-102	\$231.75

TOP AND BOTTOM CARBIDE CUTTERS WITH BEARING

PART#	PRICE
PC-15-101TB	\$538.50
PC-15-102TB	\$538.50

TOP AND BOTTOM TANTUNG® CUTTERS WITH BEARING

PART#	PRICE
PT-15-101TB	\$583.50
PT-15-102TB	\$583.50

Manufactured with 15° SHEAR to produce optimum cuts both with and across the grain. These raised panel cutters cut a 1-3/8" reveal plus a 3/8" long tongue. Reduce production time by adding an opposite rotation cutter to those above, and produce double side raised panels in a single pass. Rub bearing, spacers and tongue trimmers available.

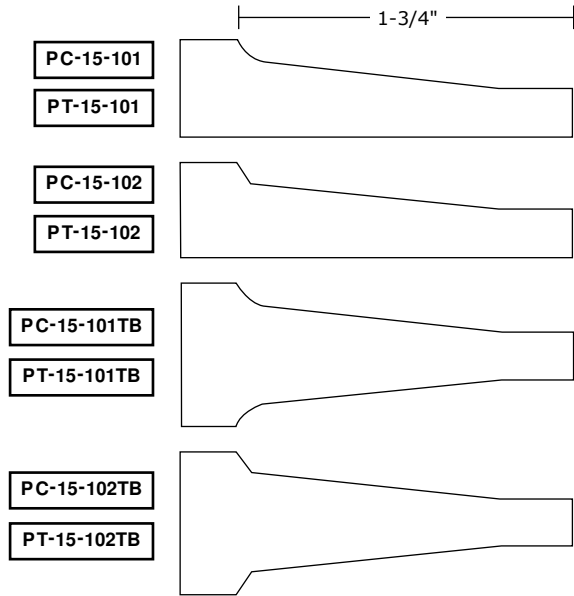

Door Edge Detail Shaper Cutters

PART#	PRICE
MC-57-021 thru 024 or 029	\$143.25
PC-17-021 thru 024 or 029	\$164.25
MT-57-021 thru 024 or 029	\$164.25
PT-17-021 thru 024 or 029	\$186.75

57-029 has a 4" diameter
17-029 has a 4-1/2" diameter

For finger pull detail, the wood was cut at a 30° incline.

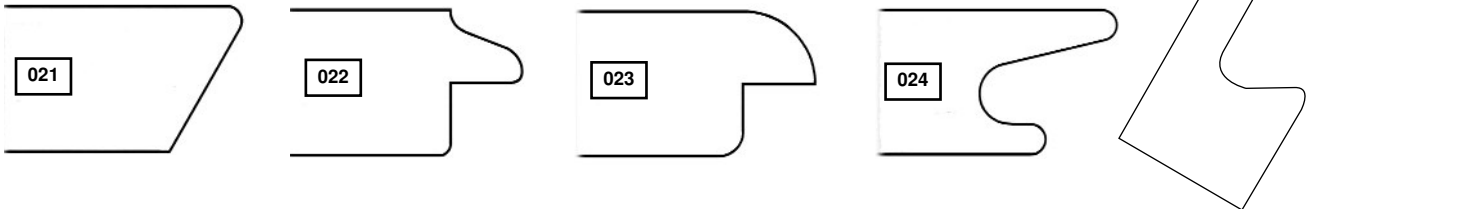

Door Edge Detail Bevel Cutters

PART#	PRICE
MC-57-025 thru 028 or 030 thru 031	\$114.00
PC-17-025 thru 028 or 030 thru 031	\$134.25
MT-57-025 thru 028 or 030 thru 031	\$129.00
PT-17-025 thru 028 or 030 thru 031	\$157.50

For a different angle or a wider bevel cutter than those shown, call us for a quote. Wood samples shown with counterclockwise rotation.

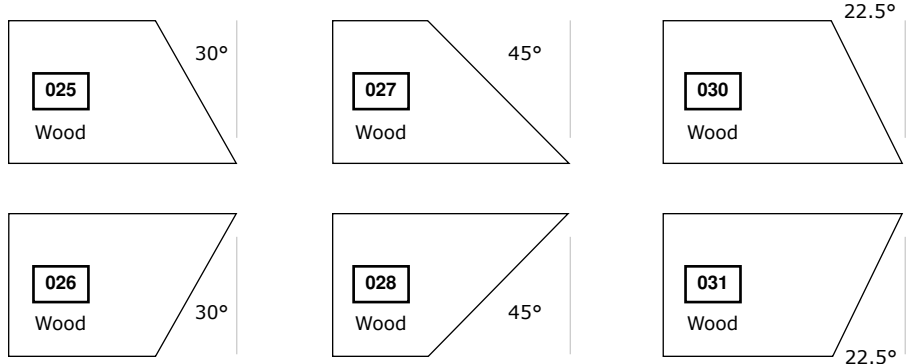

Mini-Pro Cutters: 3 wing, 3-1/2" diameter, 3/4" bore, 1" wide tips
Pro-Line Cutters: 3 wing, 4-1/2" diameter, 1-1/4" bore, 1" wide tips

Optional Glass Panel Groovers (2 Cutter Sets)

PART#	PRICE
MC-52-010 or 020	\$220.50
PC-12-010 or 020	\$237.00
MT-52-010 or 020	\$237.00
PT-12-010 or 020	\$281.25

These 2 piece glass panel groover sets run with the cope and pattern sets. Each set consists of 2 groovers 1-1/4" wide.

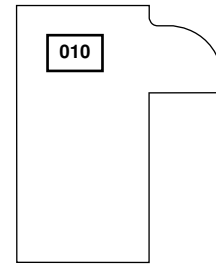
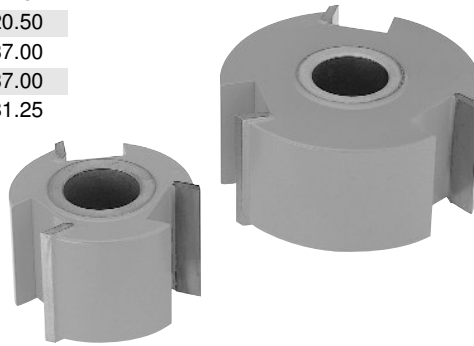

Runs with 010, 011, 040, 041 and 060

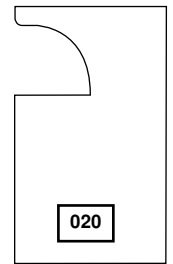

Runs with 020, 030, 050, 070 and 500

Door Edge Detail Shaper Cutters

PART#	PRICE
MC-57-001 thru 020	\$143.25
PC-17-001 thru 020	\$164.25
MT-57-001 thru 020	\$164.25
PT-17-001 thru 020	\$186.75

All of these favorites are single piece cutters and are full scale as shown. whether it is a 30° back bevel, finger-pull, 3/8" offset, or flush overlay door, we offer a wide selection to choose from. **For opposite rotation, add 60% to the list price.**

Counterclockwise rotation with wood fed face UP.

Wood Samples Shown Actual Size.

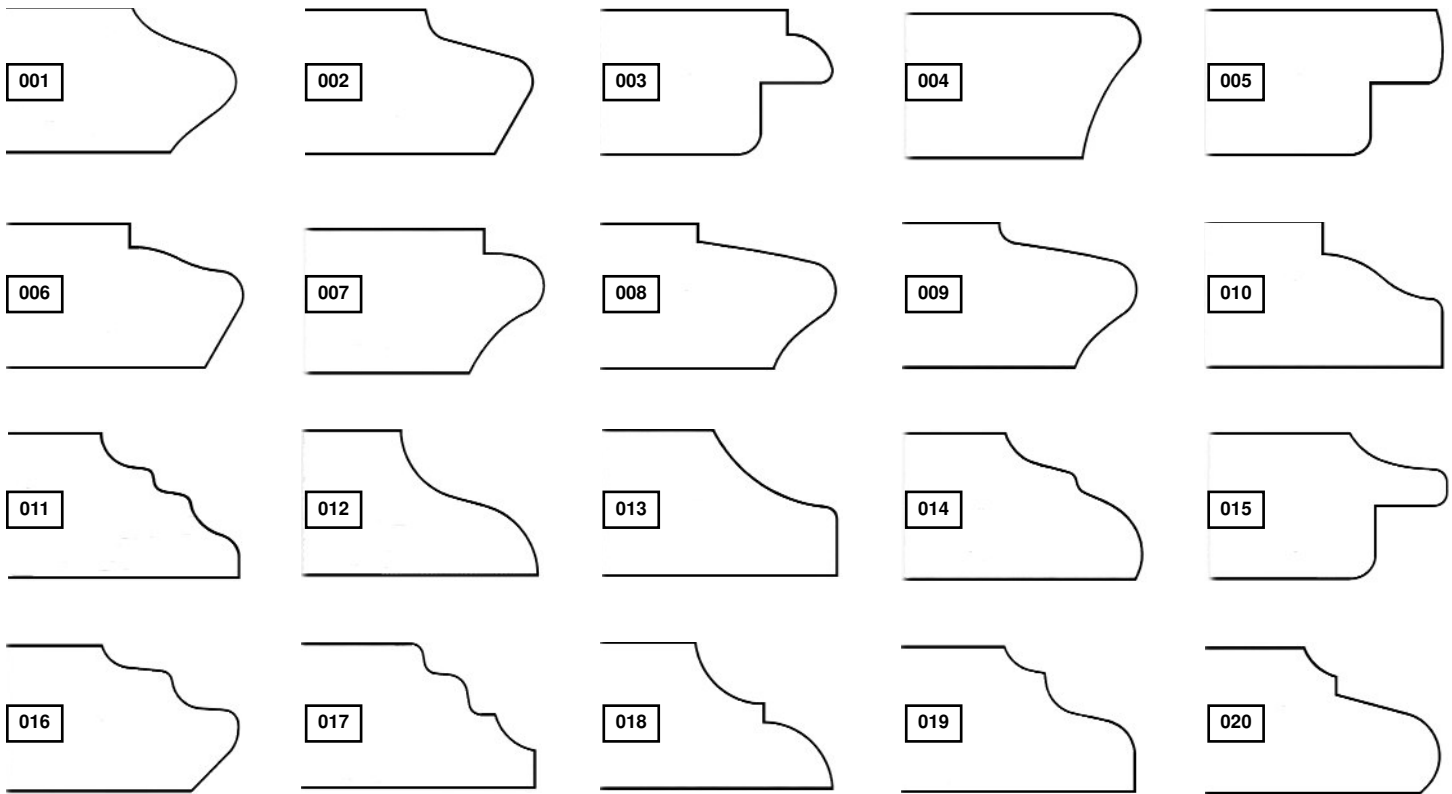

(M) Mini-Pro - 3/4" bore (P) Pro-Line - 1-1/4" bore (C) Carbide Tip - Orange (T) Tantung® Tip - Yellow

Mini-Pro Cutters: 3 wing, 2-15/16" diameter, 3/4" bore, 1" wide tips
Pro-Line Cutters: 3 wing, 4" diameter, 1-1/4" bore, 1" wide tips

FREEBORN WOOD SAMPLES ARE SHOWN ACTUAL SIZE

FREEBORN

Door Edge Details (32mm Hinge System) Top Cutter Profiles (3/4" to 7/8" Material)

PART#	PRICE
MC-57-101 thru 113	\$143.25
PC-17-101 thru 113	\$162.00
MT-57-101 thru 113	\$164.25
PT-17-101 thru 113	\$190.50

Part number is for top cutter only. Manufactured with 15° SHEAR to produce optimum cuts both with and across grain. Counterclockwise rotation with wood fed face up. Any top cutter is designed to nest and run with any Bottom Cutter. **For opposite rotation, add 60% to the sale price.**

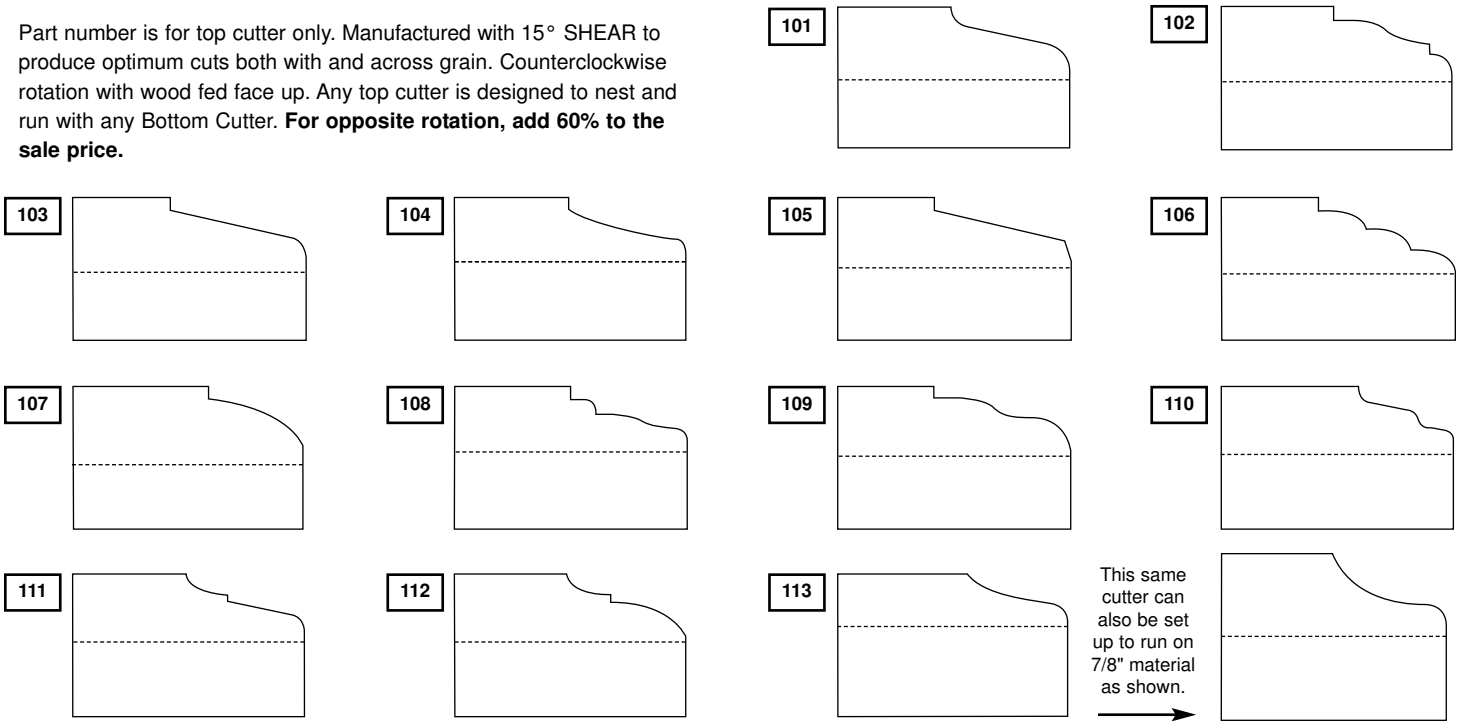

Mini-Pro Cutters: 3 wing, 2-1/16" diameter, 3/4" bore, runs with a 2-1/16" diameter rub bearing (AM-90-033 **\$40.50**)
Pro-Line Cutters: 3 wing, 3-1/16" diameter, 1-1/4" bore, runs with a 3-1/16" diameter rub bearing (AP-90-049 **\$45.75**)

Bottom Cutter Profiles

PART#	PRICE
MC-57-181 thru 185	\$117.00
PC-17-181 thru 185	\$129.75
MT-57-181 thru 185	\$129.75
PT-17-181 thru 185	\$154.50

Bottom cutters for 32mm Hinge Systems are designed to nest and run with any top cutter listed. Selection of bottom cutter should depend upon the distance of the bored hole for the hinge from the edge of the door. Manufactured to the same specifications as all top cutters.

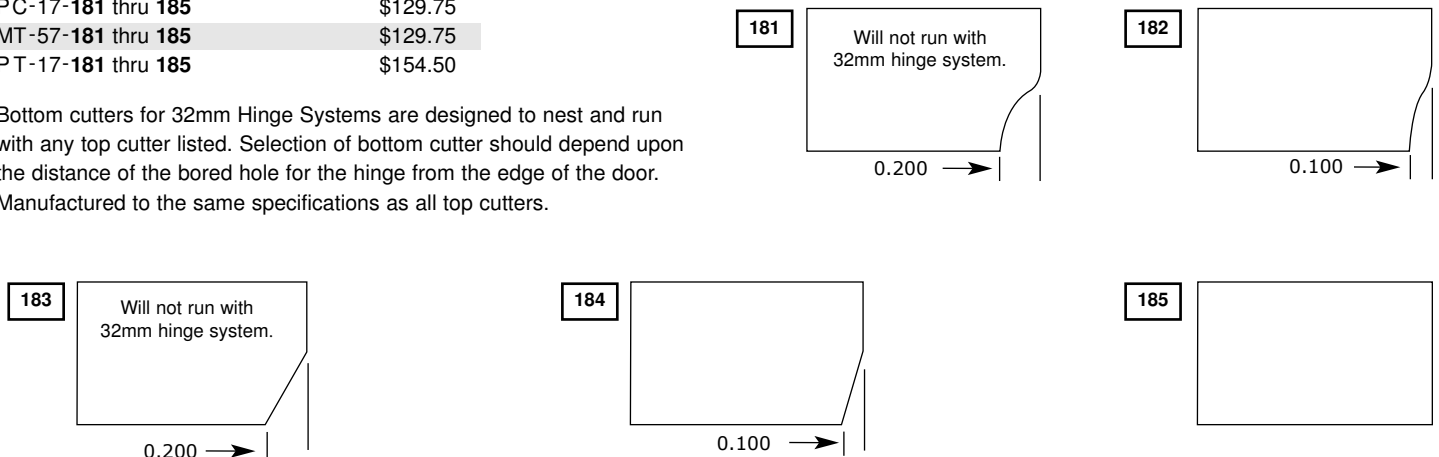

Top Cutter Profiles (7/8" to 1" Material)

PART#	PRICE
MC-57-151 thru 162	\$143.25
PC-17-151 thru 162	\$162.00
MT-57-151 thru 162	\$164.25
PT-17-151 thru 162	\$190.50

Part number is for the top cutter only.

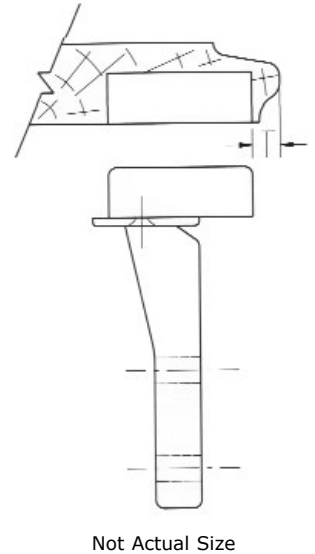
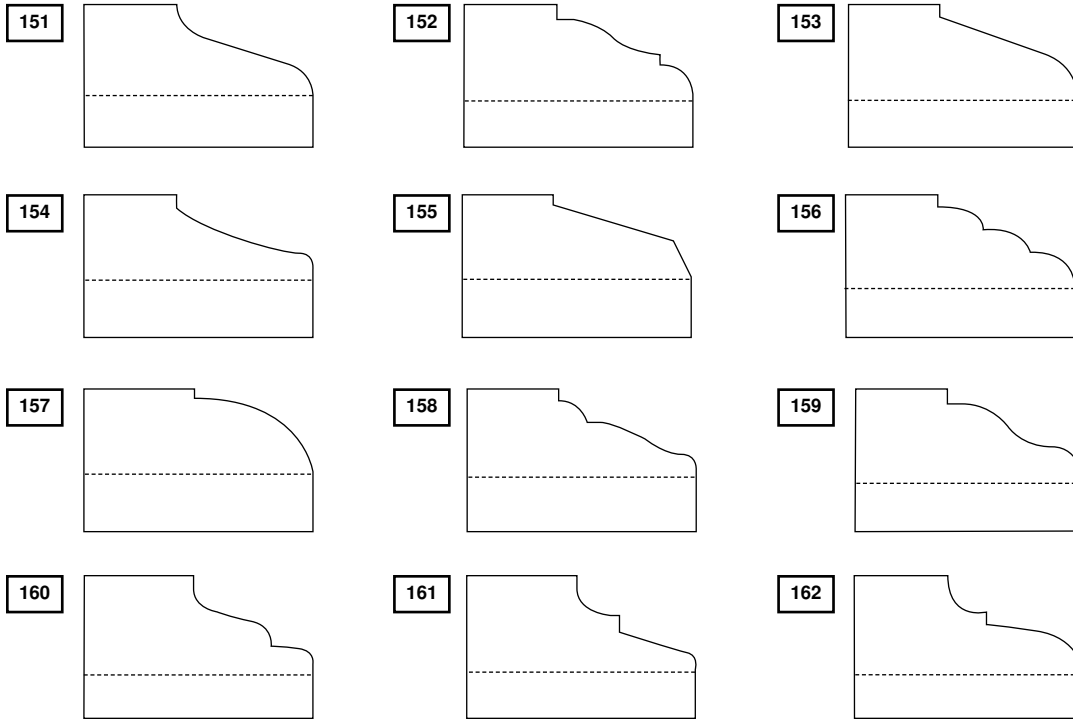

Reversible Glue Joint

PART#	PRICE
MC-58-001	\$190.50
PC-18-001	\$210.00
MT-58-001	\$224.25
PT-18-001	\$268.50

Creates an incredibly strong joint by interlocking the glue surfaces.

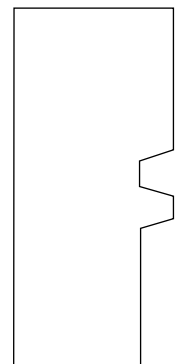
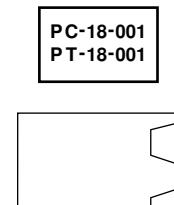
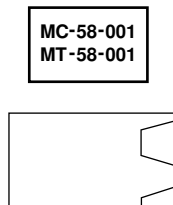

Mini-Pro Cutters: 3 wing, 2-15/16" diameter, 3/4" bore, 1" wide tips, cuts from 1/2" to 7/8" material
Pro-Line Cutters: 3 wing, 4" diameter, 1-1/4" bore, 2" wide tips, cuts from 1/2" to 1-7/8" material

V-Paneling Shaper Cutter Set (3/4" to 1" Material)

PART#	PRICE
MC-59-010	\$390.00
PC-19-010	\$458.25
MT-59-010	\$428.25
PT-19-010	\$549.75

The V-Paneling set consists of 5 cutters and 1 spacer allowing you to perform the following 4 functions. **Counterclockwise rotation with wood fed face down.**

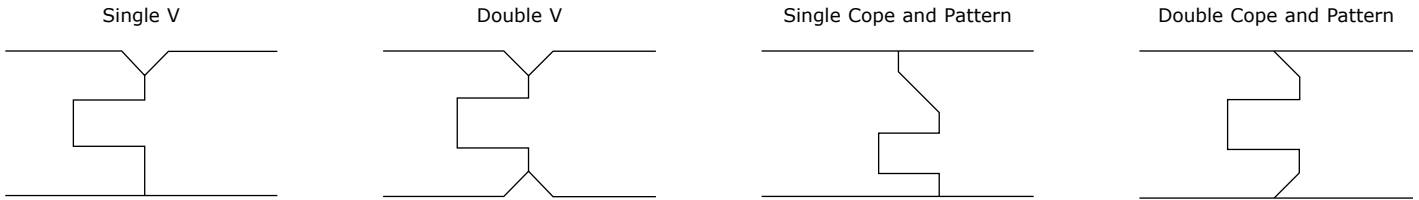

Cutter Stacking for V-Paneling Cutter Sets

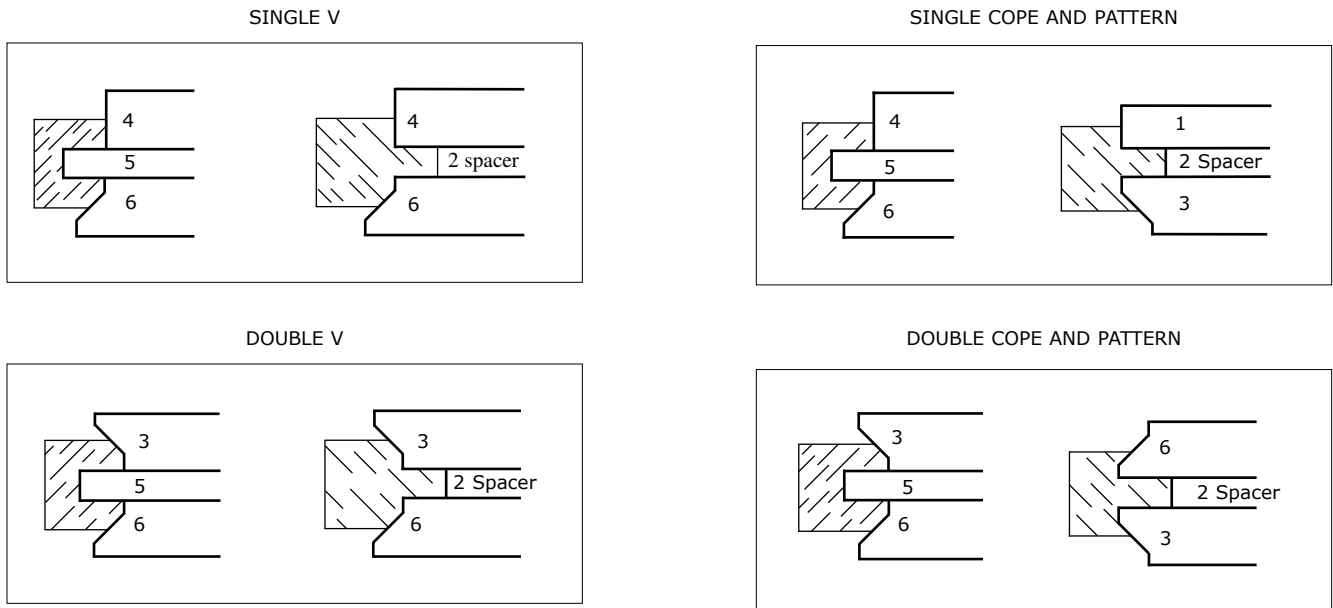

5-Piece Flooring Set with Nail Slot

PART#	PRICE
MC-59-030	\$396.75
PC-19-030	\$458.25
MT-59-030	\$435.75
PT-19-030	\$504.75

This set includes 5 cutters to perform the cut as shown up to 1-1/8" material.

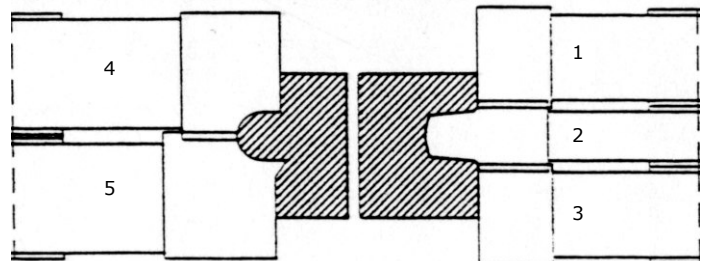
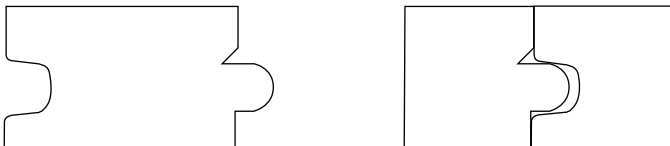
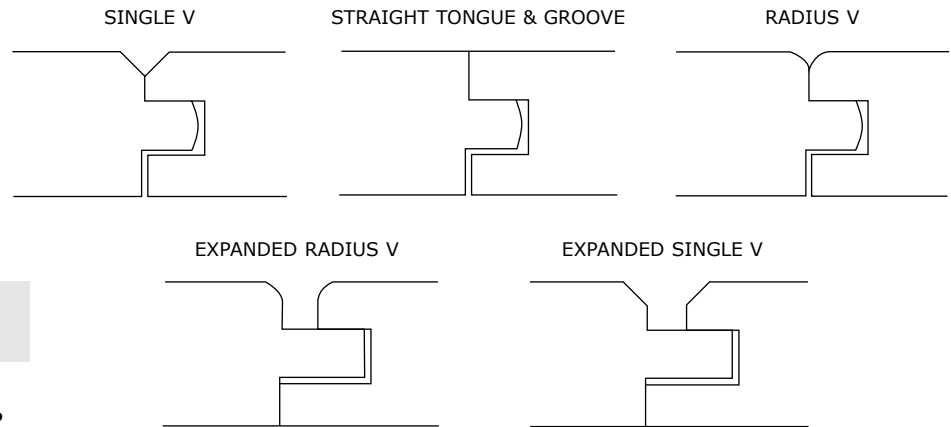

Diagram of Cutter Stacking for 5 Piece Flooring Sets. Always check spindle and fence alignment. All cutters run counter-clockwise rotation with wood face down.

7 Piece Floor Set

PART#	PRICE
MC-59-020	\$411.75
PC-19-020	\$453.00
MT-59-020	\$483.75
PT-19-020	\$532.50

The flooring set consists of 6 cutters and 1 spacer to perform these 5 functions. Cut provides a loose fit for wood expansion. Set up instructions included.



Mini-Pro Cutters: 3 wing, 2-15/16" diameter, 3/4" bore
Pro-Line Cutters: 3 wing, 4" diameter, 1-1/4" bore

ALL PROFILES ARE DESIGNED TO HAVE A .030" GAP

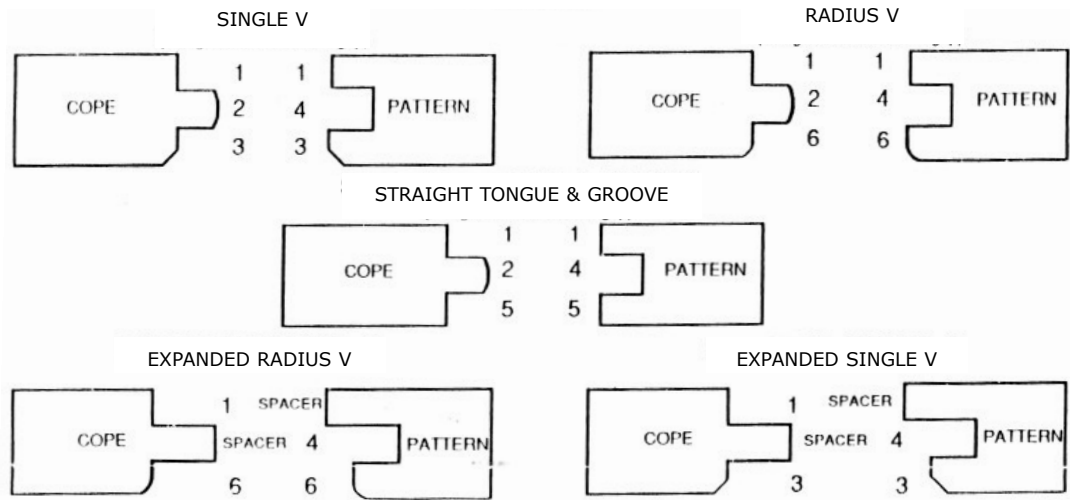

8 Piece Floor Set for 1/2" Material

PART#	PRICE
MC-59-040	\$411.75
PC-19-040	\$483.75
MT-59-040	\$453.00
PT-19-040	\$532.50

These 8 Piece Floor Sets produce both profiles shown to the right, with their respective stacking instructions shown below.

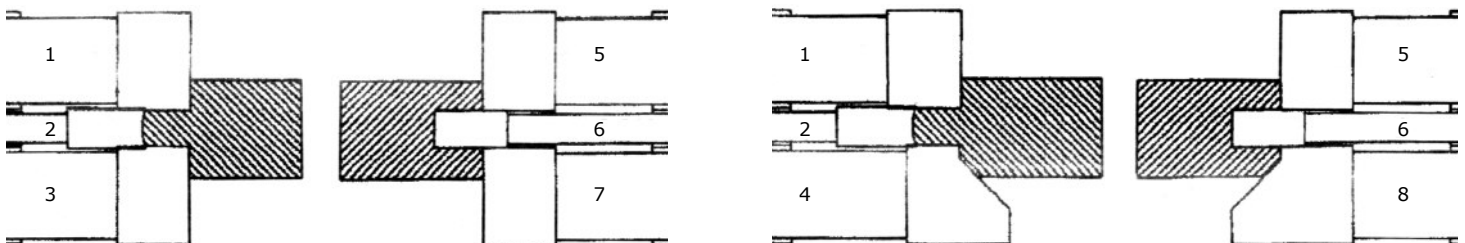
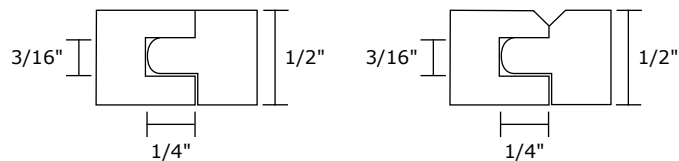

FREEBORN WOOD SAMPLES ARE SHOWN ACTUAL SIZE

FREEBORN

Straight Top Groovers

PART#	PRICE	PART#	PRICE	WIDTH	PART#	PRICE	PART#	PRICE
MC-62-004	\$69.00	MT-62-004	\$76.50	1/4	PC-22-004	\$76.50	PT-22-004	\$84.00
MC-62-005	\$70.50	MT-62-005	\$78.75	5/16	PC-22-005	\$80.50	PT-22-005	\$89.25
MC-62-006	\$72.00	MT-62-006	\$80.25	3/8	PC-22-006	\$84.75	PT-22-006	\$93.00
MC-62-007	\$75.75	MT-62-007	\$83.25	7/16	PC-22-007	\$89.25	PT-22-007	\$98.25
MC-62-008	\$79.50	MT-62-008	\$87.00	1/2	PC-22-008	\$93.00	PT-22-008	\$102.75
MC-62-010	\$83.25	MT-62-010	\$91.50	5/8	PC-22-010	\$97.50	PT-22-010	\$107.25
MC-62-012	\$87.00	MT-62-012	\$98.25	3/4	PC-22-012	\$101.25	PT-22-012	\$111.75
MC-62-014	\$90.75	MT-62-014	\$100.50	7/8	PC-22-014	\$105.75	PT-22-014	\$117.00
MC-62-016	\$93.75	MT-62-016	\$105.00	1	PC-22-016	\$110.25	PT-22-016	\$120.75
MC-62-020	\$105.75	MT-62-020	\$118.50	1-1/4	PC-22-020	\$118.50	PT-22-020	\$132.75
MC-62-024	\$111.75	MT-62-024	\$122.25	1-1/2	PC-22-024	\$131.25	PT-22-024	\$144.75
MC-62-028	\$129.75	MT-62-028	\$146.25	1-3/4	PC-22-028	\$147.75	PT-22-028	\$162.75
MC-62-032	\$144.75	MT-62-032	\$160.50	2	PC-22-032	\$160.50	PT-22-032	\$176.25

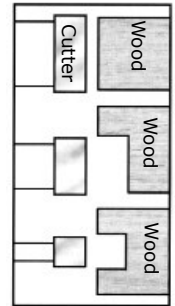

Half Round Convex Shaper Cutters (for cutting Flutes)

PART#	PRICE	PART#	PRICE	WIDTH	RADIUS	PART#	PRICE	PART#	PRICE
MC-63-002	\$79.50	MT-63-002	\$87.00	1/4	1/8	PC-23-002	\$93.00	PT-23-002	\$102.75
MC-63-003	\$86.25	MT-63-003	\$94.50	3/8	3/16	PC-23-003	\$101.25	PT-23-003	\$111.75
MC-63-004	\$97.50	MT-63-004	\$107.25	1/2	1/4	PC-23-004	\$114.00	PT-23-004	\$126.75
MC-63-006	\$108.00	MT-63-006	\$119.25	3/4	3/8	PC-23-006	\$126.75	PT-23-006	\$152.25
MC-63-008	\$136.50	MT-63-008	\$150.00	1	1/2	PC-23-008	\$160.50	PT-23-008	\$187.50

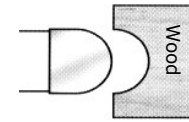

Half Round Concave Shaper Cutters

PART#	PRICE	PART#	PRICE	WIDTH	RADIUS	PART#	PRICE	PART#	PRICE
MC-64-002	\$90.00	MT-64-002	\$114.00	1/4	1/8	PC-24-002	\$114.00	PT-24-002	\$129.00
MC-64-003	\$108.00	MT-64-003	\$122.25	3/8	3/16	PC-24-003	\$122.25	PT-24-003	\$141.75
MC-64-004	\$120.75	MT-64-004	\$135.00	1/2	1/4	PC-24-004	\$135.00	PT-24-004	\$156.75
MC-64-006	\$174.75	MT-64-006	\$185.25	3/4	3/8	PC-24-006	\$185.25	PT-24-006	\$204.00
MC-64-008	\$196.50	MT-64-008	\$223.50	1	1/2	PC-24-008	\$223.50	PT-24-008	\$246.00
MC-64-009	\$203.25	MT-64-009	\$231.75	1-1/8	9/16	PC-24-009	\$231.75	PT-24-009	\$260.25
MC-64-010	\$225.75	MT-64-010	\$248.25	1-1/4	5/8	PC-24-010	\$265.50	PT-24-010	\$292.50
				1-1/2	3/4	PC-24-012	\$315.75	PT-24-012	\$348.00

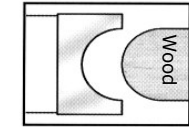
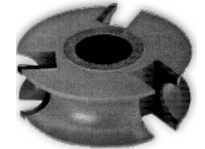

Corner Rounding Shaper Cutters

PART#	PRICE	PART#	PRICE	RADIUS	PART#	PRICE	PART#	DIA.	PRICE
MC-65-002	\$97.50	MT-65-002	\$105.75	1/8	PC-25-002	\$105.75	PT-25-002	4	\$125.25
MC-65-002R	\$97.50	MT-65-002R	\$105.75	1/8	PC-25-002R	\$105.75	PT-25-002R	4	\$125.25
MC-65-003	\$103.50	MT-65-003	\$118.50	3/16	PC-25-003	\$118.50	PT-25-003	4	\$135.75
MC-65-004	\$108.00	MT-65-004	\$126.75	1/4	PC-25-004	\$126.75	PT-25-004	4	\$141.75
MC-65-004R	\$108.00	MT-65-004R	\$126.75	1/4	PC-25-004R	\$126.75	PT-25-004R	4	\$141.75
MC-65-005	\$121.50	MT-65-005	\$135.00	5/16	PC-25-005	\$135.00	PT-25-005	4	\$148.50
MC-65-006	\$135.75	MT-65-006	\$156.00	3/8	PC-25-006	\$156.00	PT-25-006	4	\$171.75
MC-65-006R	\$135.75	MT-65-006R	\$156.00	3/8	PC-25-006R	\$156.00	PT-25-006R	4	\$171.75
MC-65-008	\$165.75	MT-65-008	\$186.75	1/2	PC-25-008	\$194.25	PT-25-008	4	\$213.00
MC-65-010	\$171.75	MT-65-010	\$199.50	5/8	PC-25-010	\$202.50	PT-25-010	4	\$222.75
MC-65-012	\$189.75	MT-65-012	\$219.00	3/4	PC-25-012	\$219.00	PT-25-012	4	\$240.75
				7/8	PC-25-014	\$227.25	PT-25-014	4	\$250.50
				1	PC-25-016	\$240.00	PT-25-016	4-1/2	\$264.75
				1-1/4	PC-25-020	\$257.25	PT-25-020	5	\$303.00
				1-1/2	PC-25-024	\$303.00	PT-25-024	5-1/2	\$356.25
				1-3/4	PC-25-028	\$395.25	PT-25-028	6	\$457.50
				2	PC-25-032	\$504.75	PT-25-032	6-1/2	\$591.00

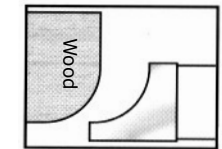

(M) Mini-Pro - 3/4" bore
 (P) Pro-Line - 1-1/4" bore
 (C) Carbide Tip - Orange
 (T) Tantung® Tip - Yellow

Mini-Pro Cutters: 3 wing, 2-15/16" diameter, 3/4" bore, designed for use with 2-15/16" diameter rub bearing for flush trim application.
Pro-Line Cutters: 3 wing, 4" diameter, 1-1/4" bore, designed for use with 4" diameter rub bearing for flush trim application.

Quarter Round Convex Cutters

PART#	RADIUS	PRICE	PART#	RADIUS	PRICE
MC-60-002	1/8	\$96.75	MC-60-008	1/2	\$150.75
PC-20-002	1/8	\$103.50	PC-20-008	1/2	\$178.50
MT-60-002	1/8	\$103.50	MT-60-008	1/2	\$178.50
PT-20-002	1/8	\$122.25	PT-20-008	1/2	\$184.50
MC-60-004	1/4	\$114.00	MC-60-012	3/4	\$184.50
PC-20-004	1/4	\$126.00	PC-20-012	3/4	\$216.00
MT-60-004	1/4	\$126.00	MT-60-012	3/4	\$216.00
PT-20-004	1/4	\$141.75	PT-20-012	3/4	\$226.50
MC-60-006	3/8	\$134.25			
PC-20-006	3/8	\$149.25			
MT-60-006	3/8	\$149.25			
PT-20-006	3/8	\$168.00			

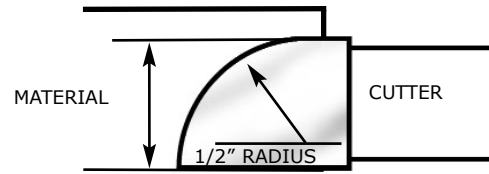

Mini-Pro Cutters: 3 wing, 2-15/16" diameter, 3/4" bore, designed for use with 2-15/16" diameter rub bearing for flush trim application.
Pro-Line Cutters: 3 wing, 4" diameter, 1-1/4" bore, designed for use with 4" dia. rub bearing for flush trim application.

Matched Drop Leaf

PART#	PRICE
MC-66-001	\$261.00
PC-26-001	\$307.50
MT-66-001	\$292.50
PT-26-001	\$360.75

Counterclockwise rotation with wood face down. When running counterclockwise, cove cut is made by lowering shaper spindle to cut with the top half of the cutter. Bead cut is made by raising shaper spindle to cut with the bottom half of the cutter.

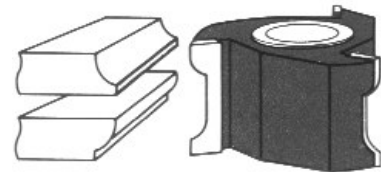
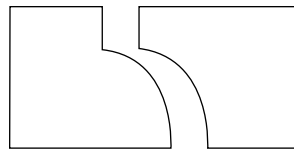

Mini-Pro Cutters: 3 wing, 2-15/16" diameter, 3/4" bore
Pro-Line Cutters: 3 wing, 4" diameter, 1-1/4" bore

Window Sash Cutter Set (4 Pieces)

PART#	PRICE
MC-67-010 or 020	\$447.75
PC-27-010 or 020	\$504.75
MT-67-010 or 020	\$500.25
PT-27-010 or 020	\$597.00

These window sash profiles are common in many older homes. The 4 cutter set is made to cut stock up to 1-3/4".

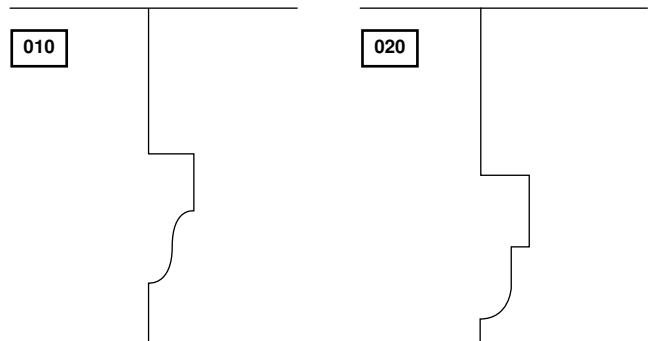
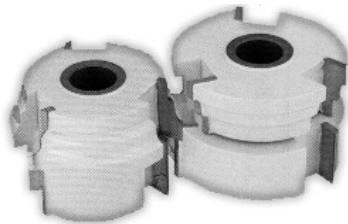

Mini-Pro Cutters: 3 wing, 2-15/16" diameter, 3/4" bore
Pro-Line Cutters: 3 wing, 4" diameter, 1-1/4" bore

Double Tongue and Groove Lock Mitre Cutter

PART#	PRICE
MC-68-001	\$204.00
PC-28-001	\$240.00
MT-68-001	\$224.25
PT-28-001	\$285.00

Counterclockwise rotation only. Mini-Pro is made to run only on 3/4" spindle. Part B is run flat in horizontal position on shaper table. Part A is run in a vertical position against the shaper fence (see diagram).

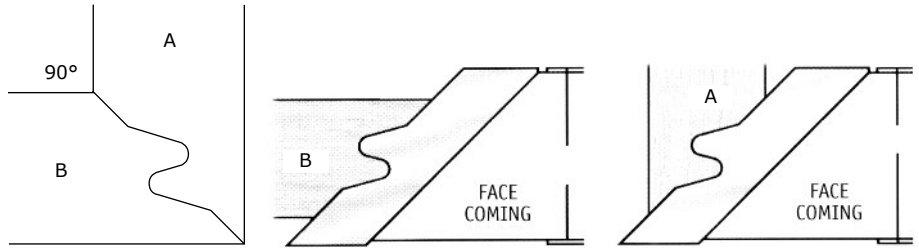

Mini-Pro Cutters: 3 wing, 4" diameter, 3/4" bore, 1-1/8" wide tips
Pro-Line Cutters: 3 wing, 5" diameter, 1-1/4" bore, 1-1/8" wide tips

Single Tongue and Groove Lock Mitre Cutter (3 Cutter Set)

PART#	PRICE
MC-68-020	\$224.50
PC-28-020	\$278.25
MT-68-020	\$268.50
PT-28-020	\$327.00

Counterclockwise rotation only. Mini-Pro is made to run only on 3/4" spindle. Part A and B are run flat in horizontal position on a shaper table. Part B is run again on table saw to cut groove (see diagram). Use on 3/4" spindles only.

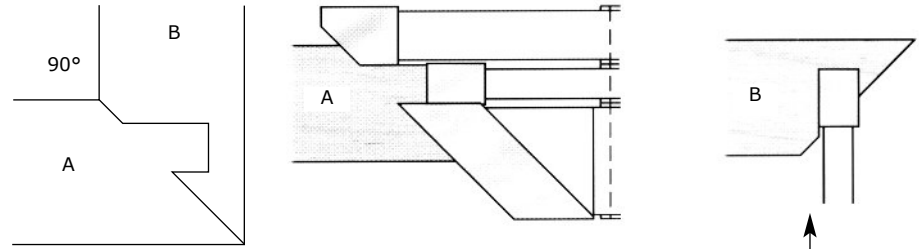

GCS-0806 1-4" Table Saw Groover \$216.75

Mini-Pro Cutters: 3 wing, 4-15/16" diameter, 3/4" bore
Pro-Line Cutters: 3 wing, 5-3/8" diameter, 1-1/4" bore

Extended Corner Rounds

Counterclockwise rotation with wood face down. For up to 1-1/4" material.

PART#	PRICE	PART#	PRICE	PART#	PRICE	PART#	PRICE
MC-73-002	\$139.50	MC-73-004	\$153.00	MC-73-006	\$170.25	MC-73-008	\$190.50
PC-73-002	\$152.25	PC-73-004	\$168.75	PC-73-006	\$187.50	PC-73-008	\$210.00
MT-73-002	\$152.25	MT-73-004	\$168.75	MT-73-006	\$187.50	MT-73-008	\$210.00
PT-73-002	\$167.25	PT-73-004	\$185.25	PT-73-006	\$204.00	PT-73-008	\$231.75

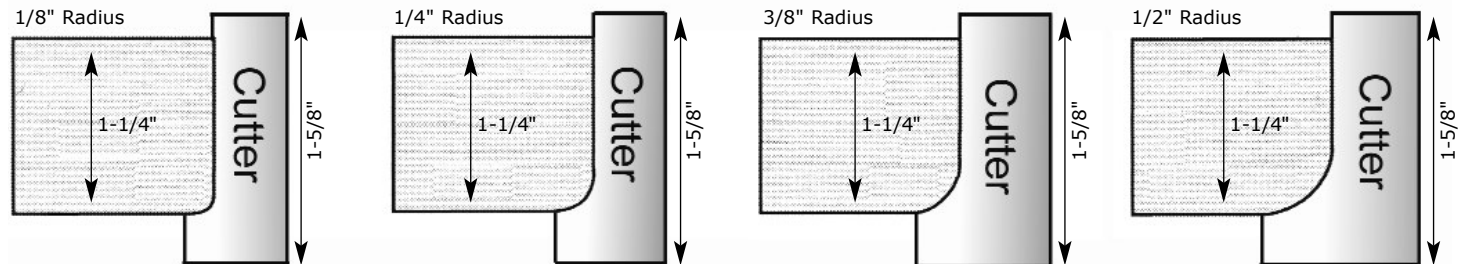

Mini-Pro Cutters: 3 wing, 2-15/16" diameter, 3/4" bore
Pro-Line Cutters: 3 wing, 4" diameter, 1-1/4" bore

Reversible Pattern Detail

PART#	PRICE
MC-21-001 thru 003	\$187.50
PC-21-001 thru 003	\$220.50
MT-21-001 thru 003	\$206.25
PT-21-001 thru 003	\$260.25

Mini-Line Cutters: 3 wing, 2-15/16" diameter, 3/4" bore, 1" wide tips
Pro-Line Cutters: 3 wing, 4" diameter, 1-1/4" bore, 1" wide tips

After machining two pieces of wood, one piece may be inverted and plugged into its mate, forming a matched joint.

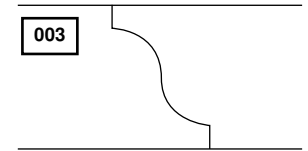
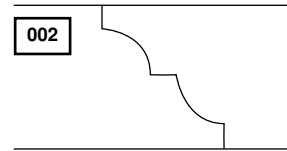
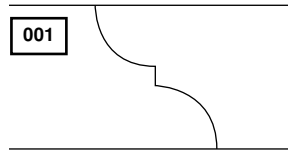

Beading Cutters

PART#	PRICE
MC-57-040 or 041	\$99.00
PC-17-040 or 041	\$114.00
MT-57-040 or 041	\$114.00
PT-17-040 or 041	\$127.50
MC-57-042	\$108.00
PC-17-042	\$122.25
MT-57-042	\$125.25
PT-17-042	\$141.75
MC-57-043	\$120.75
PC-17-043	\$135.00
MT-57-043	\$135.00
PT-17-043	\$156.75

Counterclockwise rotation with wood fed face **DOWN**.

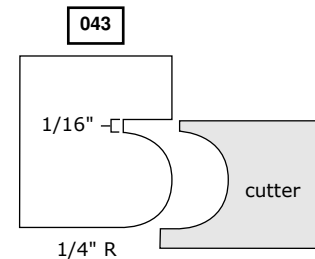
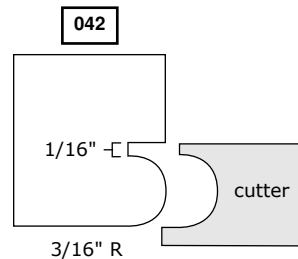
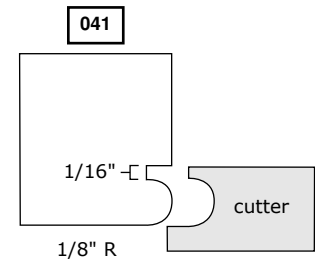
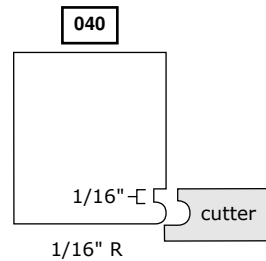

Drawer Lock Cutter

PART#	PRICE
MC-69-001	\$108.00
PC-29-001	\$118.50
MT-69-001	\$118.50
PT-29-001	\$162.75

Run drawer front face up in horizontal position over the top of the cutter. Drawer sides are run on end in a vertical position against the shaper fence. Made to cut up to 3/4" drawer sides. Counterclockwise rotation only.

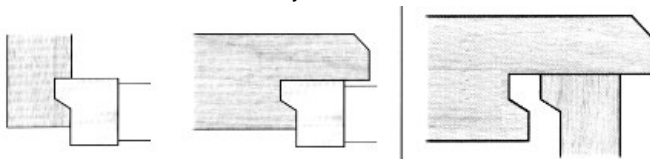

Mini-Pro Cutters: 3 wing, 2-15/16" diameter, 3/4" bore
Pro-Line Cutters: 3 wing, 5" diameter, 1-1/4" bore

Miniature Cutters

PART#	DIAMETER	BORE	WING	PRICE
TSB-1	8	5/8	6	\$243.75
TSB-2	8	5/8	6	\$243.75

Carbide Tipped Only.

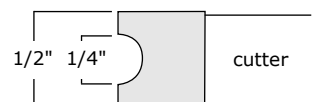
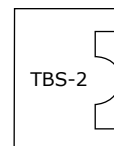
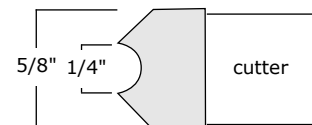
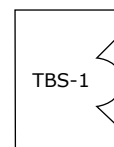

Expandable Double Easing 4 Piece Set

PART#	RADIUS	PRICE
MC-72-002	1/8	\$336.00
PC-32-002	1/8	\$378.75
MT-72-002	1/8	\$369.75
PT-32-002	1/8	\$416.25
MC-72-004	1/4	\$352.50
PC-32-004	1/4	\$399.75
MT-72-004	1/4	\$387.75
PT-32-004	1/4	\$440.25

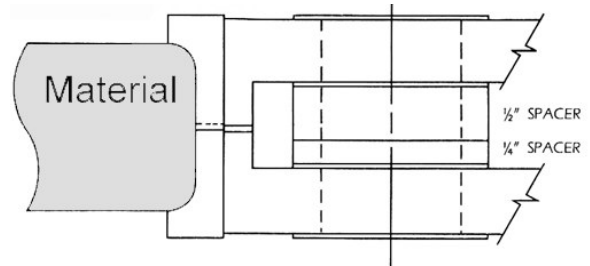

3 wing, 3" minor diameter 1-1/4" bore. Either Counterclockwise or Clockwise rotation Each set includes 2 cutters with matched radii and 2 spacers. Cut 3/4", 1", 1-1/4", and radii can be interchanged. Cutter sets can also be shimmed for additional width variations. **M** Sets have 2-3/16" minor diameter. **P** sets have 3" minor diameter.

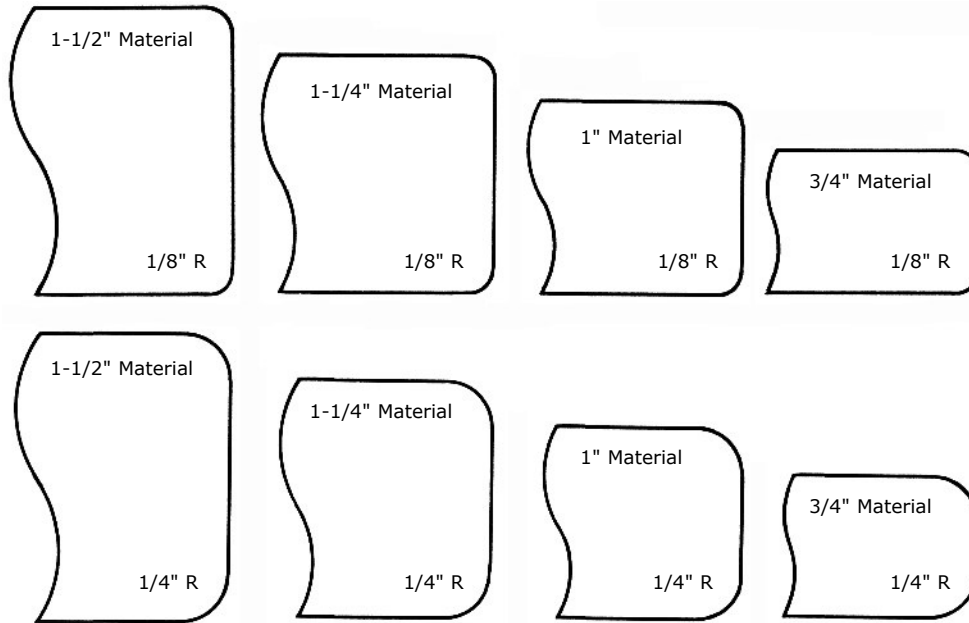

Double Easing Cutters

PART#	PRICE	PART#	PRICE	WIDTH	RADIUS	PART#	PRICE	PART#	PRICE
MC-71-006	\$105.75	MT-71-006	\$114.00	3/8	1/8	PC-31-006	\$114.00	PT-31-006	\$132.75
MC-71-008	\$114.75	MT-71-008	\$122.25	1/2	1/8	PC-31-008	\$122.25	PT-31-008	\$144.75
MC-71-012	\$128.25	MT-71-012	\$147.75	3/4	1/8	PC-31-012	\$147.75	PT-31-012	\$170.25
MC-71-016	\$138.75	MT-71-016	\$156.00	1	1/8	PC-31-016	\$156.00	PT-31-016	\$186.75
MC-71-020	\$156.00	MT-71-020	\$177.00	1-1/4	1/8	PC-31-020	\$177.00	PT-31-020	\$205.50
MC-71-024	\$161.25	MT-71-024	\$188.25	1-1/2	1/8	PC-31-024	\$189.75	PT-31-024	\$225.00

Mini-Pro Cutters: 3 wing, 2-15/16" diameter, 3/4" bore
Pro-Line Cutters: 3 wing, 4" diameter, 1-1/4" bore

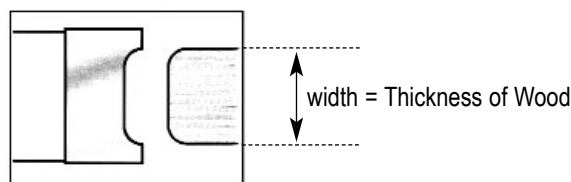

Ball Bearing Rub Collars

PART#	BORE	DIAMETER	PRICE
AM-90-026	3/4	1-5/8	\$40.50
AM-90-027	3/4	1-11/16	\$40.50
AM-90-033	3/4	2-1/16	\$40.50
AM-90-035	3/4	2-3/16	\$40.50
AM-90-047	3/4	2-15/16	\$40.50
AP-90-036	1-1/4	2-1/4	\$45.75
AP-90-040	1-1/4	2-1/2	\$45.75
AP-90-044	1-1/4	2-3/4	\$45.75
AP-90-048	1-1/4	3	\$45.75
AP-90-049	1-1/4	3-1/16	\$45.75
AP-90-052	1-1/4	3-1/4	\$45.75
AP-90-058	1-1/4	3-1/2	\$45.75
AP-90-060	1-1/4	3-3/4	\$45.75
AP-90-064	1-1/4	4	\$45.75



T-Bushings

PART#	BORE	STYLE	DIAMETER	PRICE
AM-91-008	1/2	Long	3/4	\$14.25
AX-91-012	3/4	Long	1	\$14.25
AP-91-012	3/4	Long	1-1/4	\$14.25
AP-91-016	1	Long	1-1/4	\$14.25
AP-91-016-XL*	1	Long	1-1/4	\$14.25
AP-91-017	30mm	Long	1-1/4	\$14.25
AP-91-018	1-1/8	Long	1-1/4	\$14.25

AM-92-008	1/2	Short	3/4	\$9.00
AX-92-012	3/4	Short	1	\$9.00
AP-92-008	1/2	Short	1-1/4	\$9.00
AP-92-012	3/4	Short	1-1/4	\$9.00
AP-92-016	1	Short	1-1/4	\$9.00
AP-92-017	30mm	Short	1-1/4	\$9.00
AP-92-018	1-1/8	Short	1-1/4	\$9.00

AM-93-008	1/2	Double Sided	3/4	\$8.25
AP-93-008	1/2	Double Sided	1-1/4	\$8.25
AP-93-012	3/4	Double Sided	1-1/4	\$8.25
AP-93-016	1	Double Sided	1-1/4	\$8.25
AP-93-018	1-1/8	Double Sided	1-1/4	\$8.25

Long: For 3 to 6 cutter sets. Consists of 1 long and 1 short T-Bushing
 Short: For Single Cutters. Consists of 2 short T-Bushings
 Double Sided: Designed to run between Cutter and Bearing
 * For Double Sided Sets.

SG-1 Spindle Alignment Tool

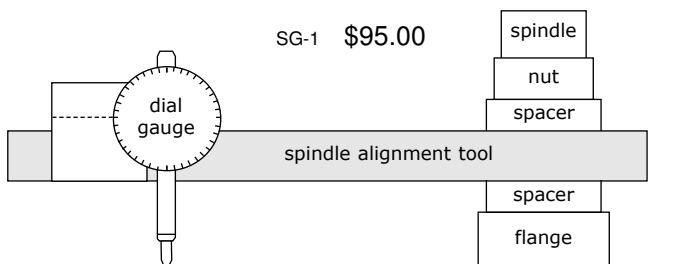

Shaper Table

Plastic Shims

PART#	BORE	QUANTITY	COLOR	THICKNESS	PRICE
AM-95-008	1/2	6	Green	.003	\$40.88
AM-95-012	3/4	6	Blue	.005	\$40.88
AP-95-016	1	6	Matte	.0075	\$40.88
AP-95-018	1-1/8	6	Brown	.10	\$40.88
AP-95-020	1-1/4	6	Black	.0125	\$40.88
		6	Pink	.015	\$40.88
		6	Yellow	.020	\$40.88
		6	Coral	.030	\$40.88

Sets of 48 color-coded plastic shims for various spacing needs.

Metal Shims

PART#	BORE	PRICE
C-470	1/2	\$25.00
C-471	3/4	\$25.00
C-472	1	\$25.00
C-473	1-1/8	\$25.00
C-474	1-1/4	\$25.00

Each set contains 19 shims including one each of the following thickness: .001", .0015", .002", .003", .004", .005", .006", .007", .008", .010", .012", .015", .020", .025", .031", .047", .062", .093" and .125"

Spacers

PART#	BORE	WIDTH	PRICE
AM-94-002	3/4	1/8	\$17.25
AM-94-004	3/4	1/4	\$17.25
AM-94-006	3/4	3/8	\$17.25
AM-94-008	3/4	1/2	\$17.25
AM-94-010	3/4	5/8	\$17.25
AM-94-012	3/4	3/4	\$17.25
AM-94-016	3/4	1	\$17.25
AP-94-002	1-1/4	1/8	\$17.25
AP-94-004	1-1/4	1/4	\$17.25
AP-94-006	1-1/4	3/8	\$17.25
AP-94-008	1-1/4	1/2	\$17.25
AP-94-010	1-1/4	5/8	\$17.25
AP-94-012	1-1/4	3/4	\$17.25
AP-94-016	1-1/4	1	\$17.25

The Shaper Book

by Lonnie Bird

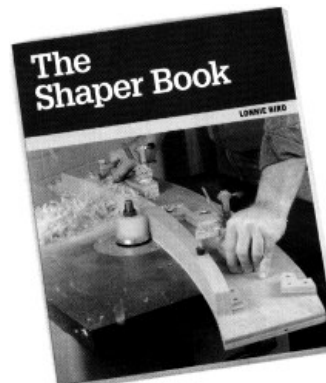

More than just a primer on shaper techniques, this book gives shop-proven examples of how the shaper can be put to use. With an emphasis on safety, this book is a step-by-step guide that will teach you all about the shaper: from basic setups to cutting curved molding profiles to designing shaper jigs that will expand your woodworking potential.

\$19.95

FREEBORN

Cope and Pattern Insert Cutters (3/4" to 7/8" Material)

**INSERT
TOOLING**

PART#	OUTSIDE DIAMETER	MINOR DIAMETER	PRICE
I-10-010 thru 500	4-1/2	3-1/2	\$599.00
I-10-010-Eased thru 500-Eased	4-1/2	3-1/2	\$599.00

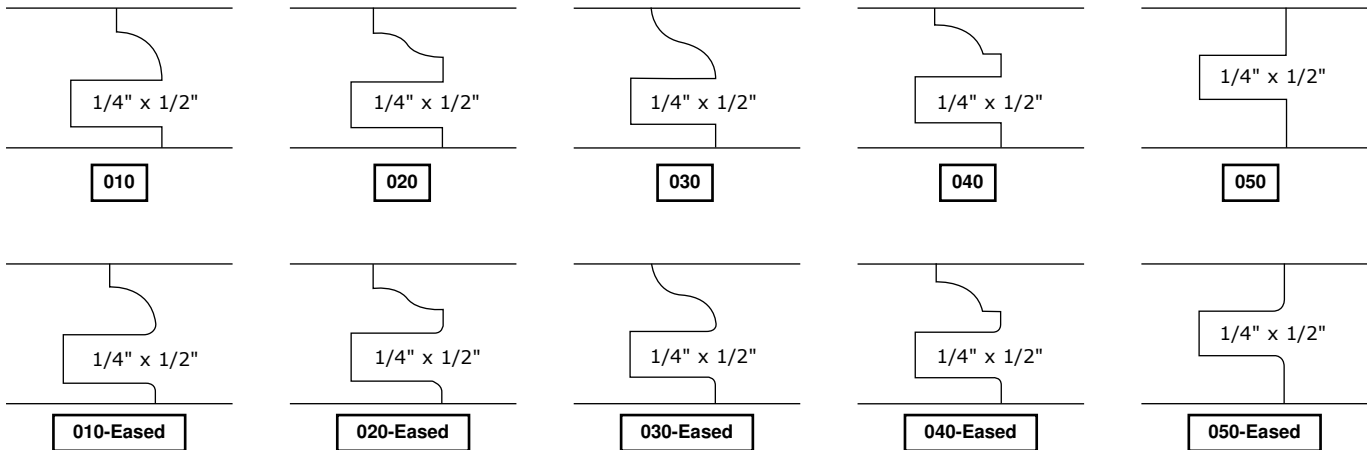

Raised Panel Insert Cutters (3/4" Material)

**INSERT
TOOLING**

PART#	OUTSIDE DIAMETER	MINOR DIAMETER	PRICE
I-14-001 thru 007	6	3	\$299.00

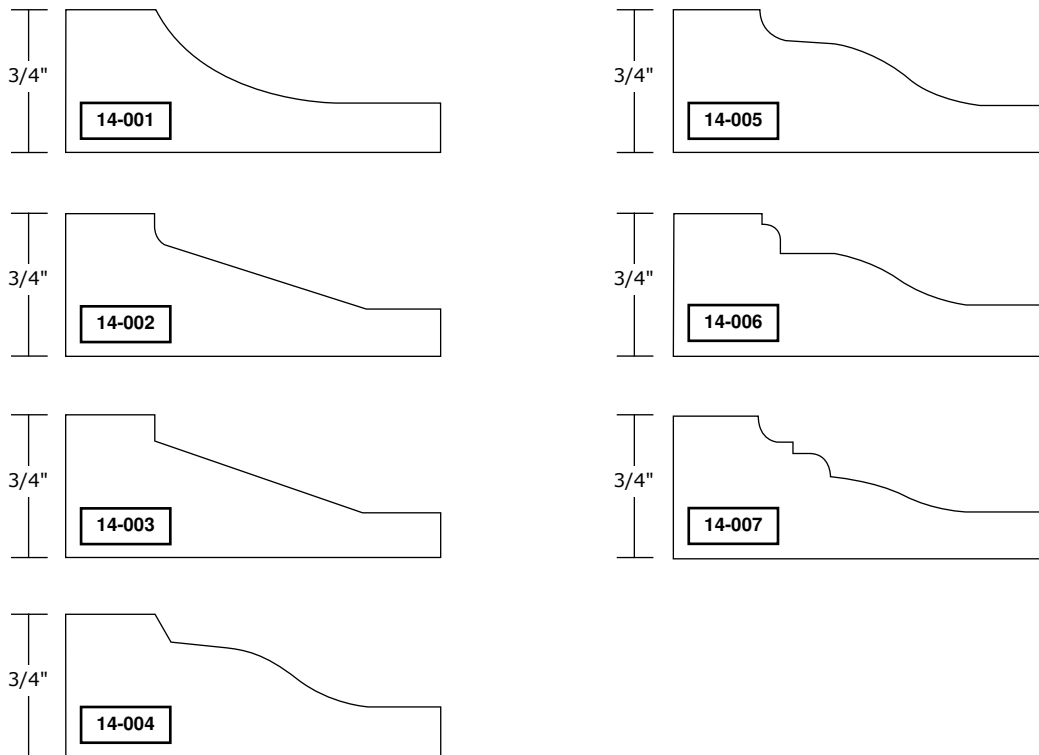

Raised Panel Insert Cutters (5/8" Material)



PART#	OUTSIDE DIAMETER	MINOR DIAMETER	PRICE
I-15-001 thru 007	6	3	\$299.00

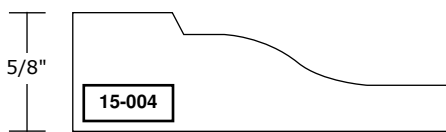
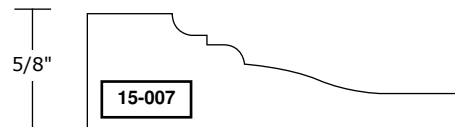
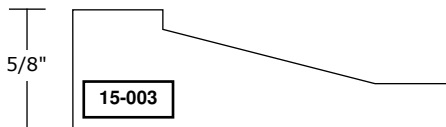
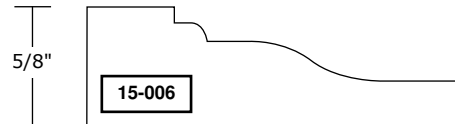
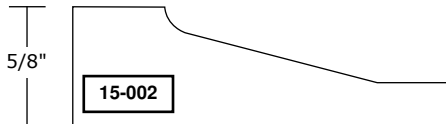
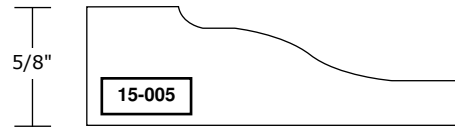
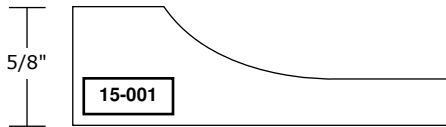

Back Cutter - Raised Panel

PART#	PRICE
I-16-001	\$225.00

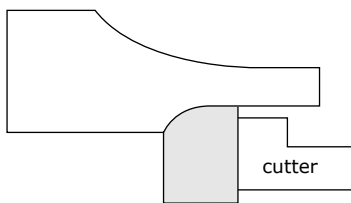

Door Edge Detail Insert Cutters

PART#	PRICE
I-17-001 thru 003	\$249.00

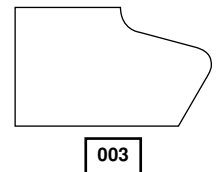
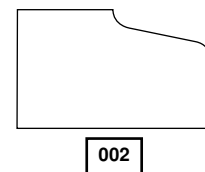
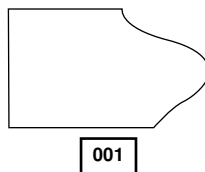

FREEBORN CLEARANCE - SIGNATURE SERIES WHILE SUPPLIES LAST

Although not as versatile as the Pro-Line and Mini-Pro series, you'll find the 2 wing Signature Series an exceptional value. Designed for 1/2" and 3/4" spindles, these carbide tipped shaper cutters are manufactured with the same precision you expect from Freeborn Tool Company. Many of our customers find them ideal for smaller jobs or hand-fed projects that require a high level of quality and exactness.

Cope and Pattern (6 Piece Set)

PART#	PRICE
SC-50-010 thru 040	\$173.40

Our standard sets cut 1/4" wide x 3/8" deep tongue and groove. Counterclockwise rotation with wood fed face down. These 6 cutter sets are designed to perform cope and pattern cut as shown. 3/4" bore, 2 Wing Only.

Signature Series: 2 wing, 2-15/16" diameter, 3/4" bore, Carbide-Tipped, designed to run with a 2-3/16" diameter run bearing (AM-90-035) **\$40.50**

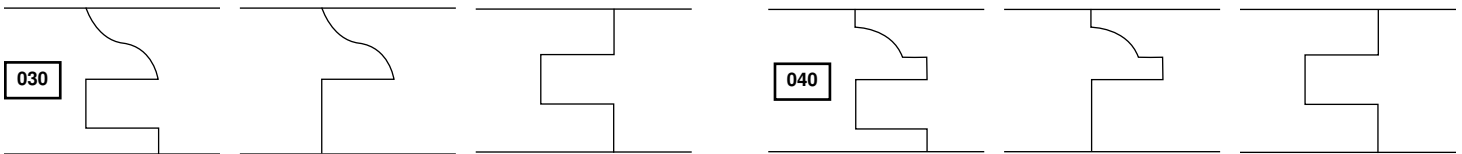

Raised Panel Cutters

PART#	PRICE
SC-54-002	\$94.20
SC-54-005	\$94.20
SC-55-003	\$94.20

Manufactured with 15° SHEAR to produce optimum cuts both with and across grain. Counterclockwise rotation with wood fed face up.

Signature Series: 2 wing, 4-1/2" diameter, 3/4" bore, Carbide-Tipped, designed to run with a 1-5/8" diameter run bearing (AM-90-026) **\$40.50**

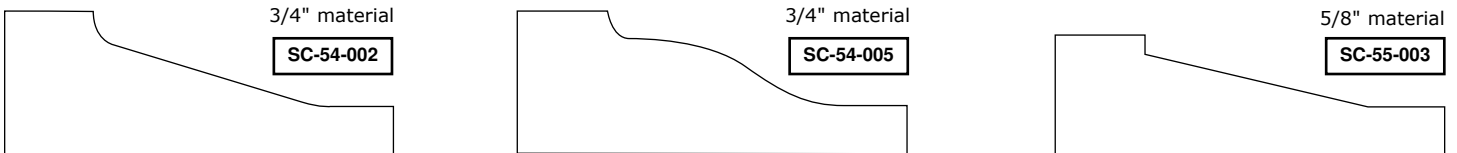

Reversible Glue Joint

PART#	PRICE
SC-58-001	\$94.80

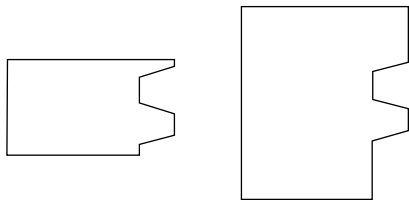

Signature Series: 2 wing, 2-15/16" diameter, 3/4" bore, Carbide-Tipped

Straight Top Groovers

PART#	WIDTH	PRICE
SC-62-004	1/4	\$34.20
SC-62-006	3/8	\$36.00
SC-62-008	1/2	\$39.00
SC-62-012	3/4	\$43.20
SC-62-016	1	\$46.80
SC-62-024	1-1/2	\$55.20
SC-62-032	2	\$72.00

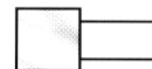

Signature Series: 2 wing, 2-15/16" diameter, 3/4" bore, Carbide-Tipped, designed to run with a 2-15/16" diameter run bearing (AM-90-047) **\$45.75** for flush trim applications

FREEBORN CLEARANCE - SIGNATURE SERIES WHILE SUPPLIES LAST

Back Cutters - Raised Panel

PART#	PRICE
SC-56-001	\$70.80
SC-56-002	\$70.80

Does not include Raised Panel Cutter. Manufactured with 15° SHEAR to produce optimum cuts both with and across grain. Spacer provided to allow 1/4" tongue as shown.

Signature Series: 2 wing, 3-3/8" diameter, 3/4" bore, Carbide-Tipped, designed to run with any SC-55 series raised panel cutter to cut 3/4" panel

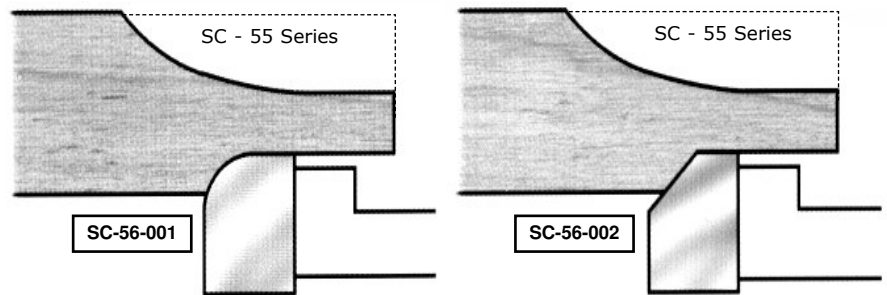

Door Edge Detail Cutters

PART#	PRICE
SC-57-001	\$71.40
SC-57-004	\$71.40
SC-57-009	\$71.40
SC-57-023	\$71.40

Door Edge Detail cutters have a 1" wide tip. Counterclockwise rotation with wood fed face up.

Signature Series: 2 wing, 2-15/16" diameter, 3/4" bore, Carbide-Tipped,



Rounding Cutters

Half Round Concave Cutters have .030" flare for easy bull nosing.

HALF ROUND CONVEX

PART#	WIDTH	RADIUS	PRICE
SC-63-002	1/4	1/8	\$39.00
SC-63-003	3/8	3/16	\$42.60
SC-63-006	3/4	3/8	\$53.40
SC-63-008	1	1/2	\$67.80

HALF ROUND CONCAVE

PART#	OPENING	RADIUS	PRICE
SC-64-002	1/4	1/8	\$49.20
SC-64-003	3/8	3/16	\$54.00
SC-64-004	1/2	1/4	\$60.00
SC-64-006	3/4	3/8	\$87.00
SC-64-008	1	1/2	\$97.80

CORNER ROUNDING

PART#	RADIUS	PRICE
SC-65-006	3/8	\$67.80
SC-65-008	1/2	\$82.20
SC-65-012	3/4	\$94.80

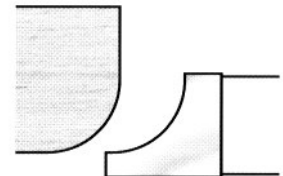
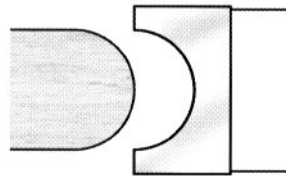
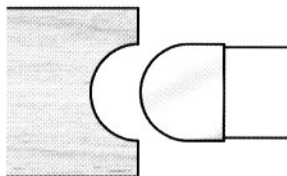

Signature Series: 2 wing, 2-15/16" diameter, 3/4" bore, Carbide-Tipped

Signature Series: 2 wing, 2-15/16" diameter, 3/4" bore, Carbide-Tipped

Signature Series: 2 wing, 2-15/16" diameter, 3/4" bore, Carbide-Tipped

FREEBORN WOOD SAMPLES ARE SHOWN ACTUAL SIZE

FREEBORN